

**NOT
ONLY
WHITE®**



NOT ONLY WHITE®

Not Only White's collection of bathroom products is designed and curated to create simple pleasures in life. Brought back to the basics, yet always with a touch of warmth and elegance.

Our collection is inviting to touch, as how it should be in a bathroom. A bathroom is a sensory and sensual space. A space where you feel at ease from the moment you step in. To refresh for just a few minutes or fully immerse and lose track of time.

We realize options are limitless these days and every decision takes your time. Therefor at Not Only White we aim to keep it simple and clear. We believe in luxury, but always sophisticated and modest.

Not Only White is dedicated to make sure our collections are well-balanced, refined and meet your needs. This way we can create simple pleasures for you.

Refined luxury, simple pleasures.





Fine bath



Muse Palette bath



Still Palette countertop basin



Frame basin



Still countertop basin



Pose Palette basin



Scape basin



Nest Soft Touch countertop basin



Fall countertop basin



Loop Soft Touch bath

Content

Custom Made by Not Only White explained	6
Materials and colors	9
Palette finish	9
Soft Touch coating	9

Custom Made basins

Base	13
Blend	19
Box	23
Form	27
Mono	33
Noon	37
Unit cabinet	41
Basq tray	45
Flat shelf	47

Basins

Aim	49
Box countertop	53
Fall countertop	55
Frame	59
Fuse	63
Nest countertop	67
Noon countertop	71
Pose	73
Scape	79
Still countertop	83

Tapware

Leaf single lever tap	91
Leaf spout with mixer	93

Baths

Axis	97
Ease	99
Fine	101
Loop	107
Muse	111
Bath tray for Axis and Loop	113

Handrinse basins

Base handrinse	
Models	115
Custom	120
Base Light handrinse	
Models	117
Custom	120
Base Bold handrinse	
Models	119
Custom	120
Blend handrinse	
Models	123
Custom	126
Form handrinse	
Models	129
Custom	132
Form Light handrinse	
Models	131
Custom	132
Kuub handrinse	
Models	135
Custom	138
Kuub Light handrinse	
Models	137
Custom	138
Noon handrinse	
Models	141
Custom	142



Custom Made by Not Only White explained

With Not Only White, you can create the perfect solution for every bathroom or toilet, be it at home, in a hotel, restaurant, office, etc. This is achieved by having our products made to order according to the client's wishes, based on our collection elements.

Our *Custom Made* system provides the flexibility to adjust the washbasin's width, depth and height accordingly to the client's needs and wishes. Even the position and number of bowls can easily be modified. *Custom Made* also means having the ability to leave out what is unnecessary. In the case that a wall covers one side edge of a washbasin, this edge is not visible and thus not needed. It will be left out in the calculation of the product pricing.

In the next pages, our *Custom Made* system will be explained in detail.

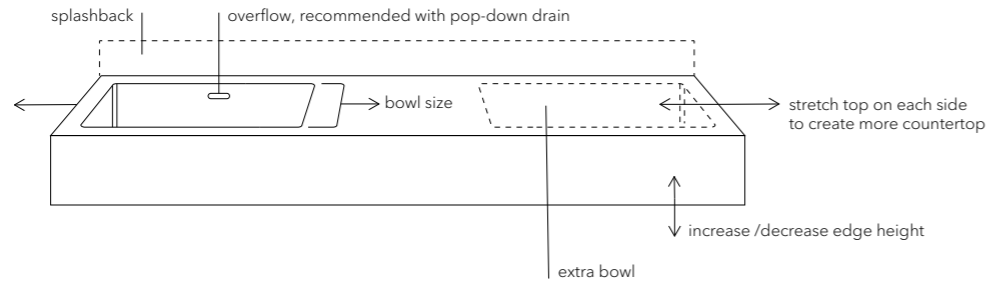

1. Choose the bowl design

The Not Only White collection offers a range of 6 different designs: Base, Blend, Box, Form, Mono and Noon.

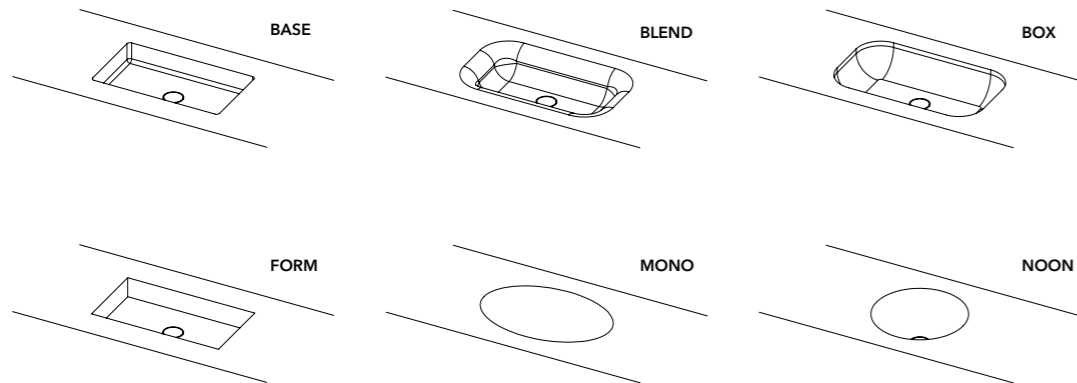

2. Choose the composition

The next step is to define the composition. Our collection offers washbasins in many variations.

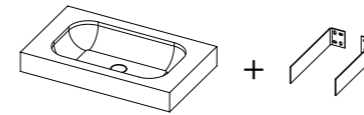

Washbasin wall-mounted

The washbasin is mounted to the wall with brackets.

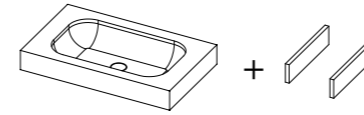

Washbasin top-mounted

The washbasin has to be mounted on top of a shelf or cabinet and is supplied with fixed plywood ribs for support.

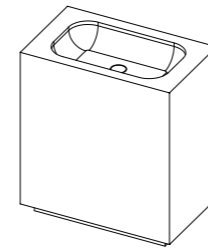

Washbasin floor-standing

The washbasin has a 50mm high plinth and 4 adjustable feet.

4 ways to combine a custom made washbasin with a cabinet:

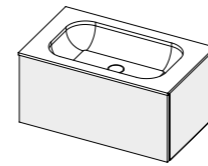

Washbasin in cabinet

The thin washbasin top is directly supported by the cabinet body and the bowl sits inside the cabinet.

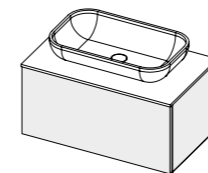

Countertop washbasin on cabinet

The washbasin is a countertop model and sits on top of a cabinet (or shelf). Not Only White offers 4 countertop washbasins: Box, Nest, Noon and Still.

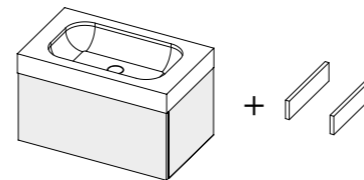

Washbasin on cabinet

The washbasin sits directly on top of the cabinet. Ribs are added underneath the washbasin. These ribs strengthen the washbasin and are necessary to install the washbasin onto the cabinet.

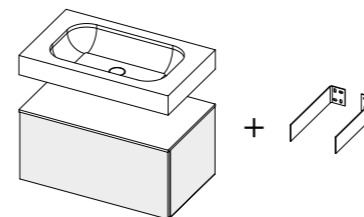

Washbasin separate from cabinet

The washbasin is supported by brackets.

3. Define the dimensions

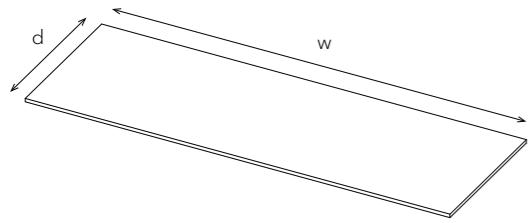

Top

Whether you want a wall-to-wall or a smaller sized 'free-hanging' washbasin, start with deciding on the dimensions of the top. This will also determine the size and number of bowls that the top can accommodate.

Top is calculated in m²

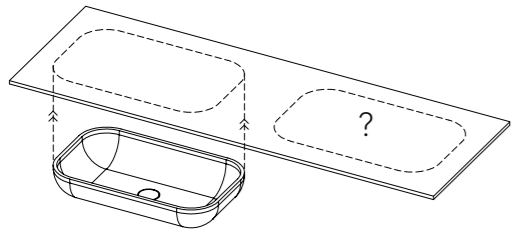

Bowl(s)

Now that you know the overall dimensions, the next step is to determine the bowl(s) of your choice (e.g. Base, Blend, etc....) to create the look of your Custom basin.

Not Only White offers multiple sizes for most bowl designs. You have the choice of fitting **one or multiple bowls** in your top.

Bowls are calculated per piece

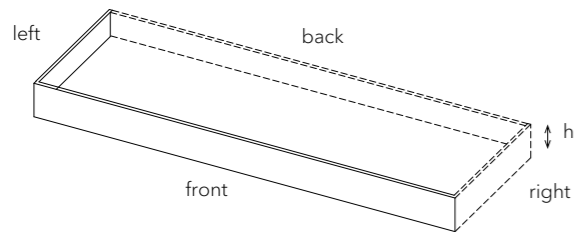

Edge

Edges can be added to the top and vary from 20mm up to 900mm high. A washbasin with a 900mm high edge is what we call a floor-standing model.

Have a look below which edges are necessary in your situation.

Edges up to 200mm high are calculated per running meter

SITUATIONS

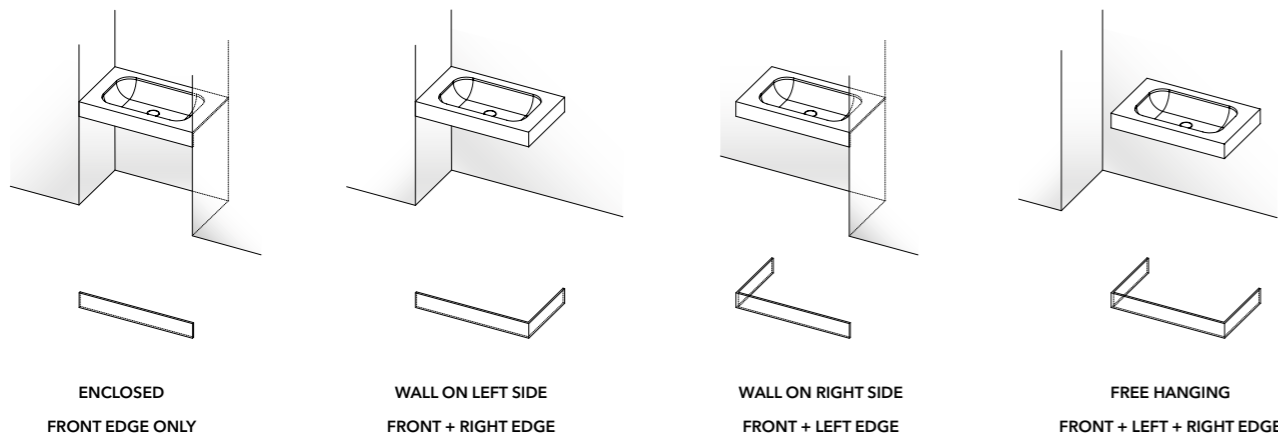

4. Continue with more options

Tap hole

If you need to fit a top-mounted tap, we can pre-drill the hole (code **HH35**).

Tap hole is calculated per bowl

Consider the space you would need to secure the tap with a tightening ring.

Top-mounted tap without overflow:

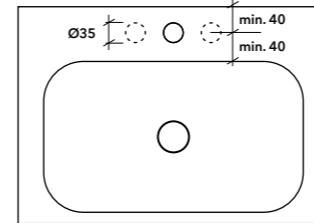

Top-mounted tap with overflow:

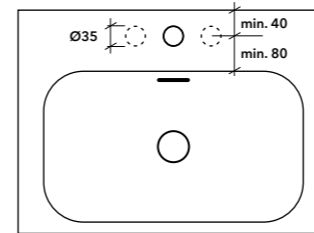

Overflow

An overflow (code **OH50**) is used for bowls equipped with a closable drain.

Overflow is calculated per bowl.

The overflow drain tube needs at least 50mm at the back of the washbasin to fit.

The overflow ring, that drains excess water into the drain, adds 30mm of height underneath the basin drain.

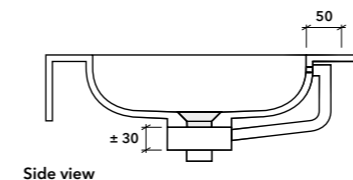

Side view

Drain type

Depending on how the washbasin needs to look and work, you can choose from different drain types for Base, Blend, Box, Form, Mono and Noon.



1 FLUSH DRAIN
free flow drain

All Himacs bowls (except for Kuub handrinse and Scape) are standard equipped with our Flush drain. This drain allows water to flow through at all times and cannot be closed.

Flush drain is free of charge



2 POP-DOWN DRAIN
closable drain

Our Pop-down drain has the same aesthetic as the Flush drain but it can be pressed down to close the drain.

Pop-down drain is calculated per bowl

Not Only White recommends to pair the Pop-down drain with an overflow.



3 DR72 DRAIN HOLE
for a third party drain

The DR72 drain hole is used for third party drains, both closable and non-closable.

DR72 drain is free of charge

Not Only White recommends to pair a third party closable drain with an overflow.

Materials and colors

Base, Blend, Box, Flat, Form, Frame, Kuub, Mono and Noon are made of S28 Alpine White Himacs®.

Accessory range Basq and the bath trays are made of Himacs® and come in different colors. Basq also comes in Natural Oak veneer.

Axis, Ease, Fine, Loop and Muse baths as well as Aim, Fuse, Nest, Pose and Still washbasins are made of white Velluto® biobased.

Aim is available with Soft Touch coating on the outside in RAL 9005.

Fuse is available with Soft Touch coating on the outside in RAL 5008 and RAL 7044.

Pose, Nest and Still washbasins as well as Ease, Fine, Loop and Muse baths are available with Soft Touch coating or Palette finish.

Fall is available in S28 Alpine White, G004 White Quartz, G038 Sea Oat Quartz and G100 Peanut Butter Himacs®.

Scape is available in S28 Alpine White and S22 Black Himacs®.

Palette finish



Palette is a two-component acrylic-polyurethane and pigmented paint, which is applied on our Velluto® biobased solid surface collections. On the inside and outside.

Palette is easy to clean and UV resistant. Because of the availability in all NCS and RAL colors, design professionals can create a unique and distinctive aesthetic appearance in both residential and commercial projects.

Soft Touch coating



Soft Touch finish consists of two layers. The first layer is a two-component acrylic matt base coating with excellent adhesion and light resistance. The second layer is a two-component transparent polyurethane coating with soft touch effect in order to create that distinctive homogeneous, velvety tactile experience.

Because of the availability in all NCS and RAL colors, design professionals can create a unique and distinctive aesthetic appearance in both residential and commercial projects.

5. Cut-outs and edge finishing

Edge cut-out

Edge cut-outs are calculated per piece

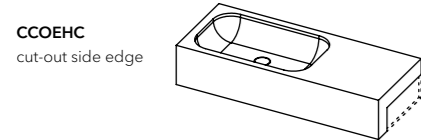
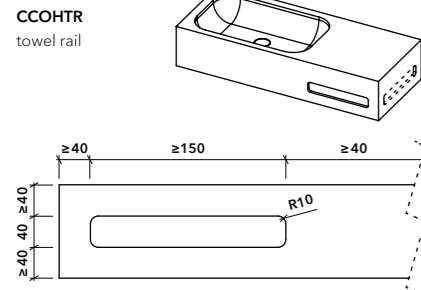

Integrated backsplash

An integrated backsplash can be applied on all Himacs washbasins (code **CSP90H**) with a maximum height of 90mm.

Integrated backsplash is calculated per running meter

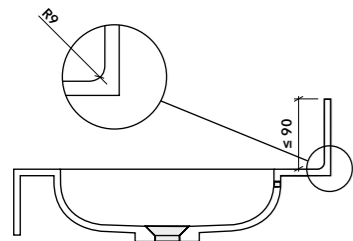

Note that a backsplash with a height over 90mm will be supplied as a separate piece without a radius edge.

Separate backsplash is calculated per m²

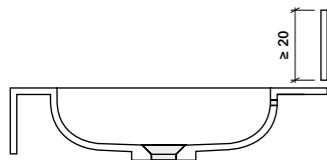

Recessed edge

For washbasins placed on cabinets with recessed fronts, a 50mm recessed edge (code **CRE50**) is available to close off a part of the underside.

Recessed edge is calculated per running meter

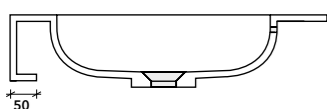

Top cut-out

Top cut-outs are calculated per piece

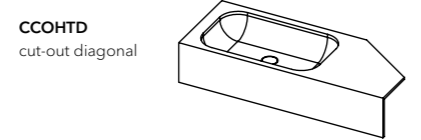
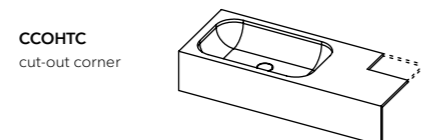
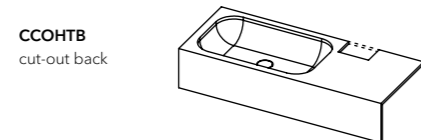
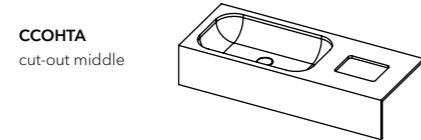

Unit

Add the Unit for some extra storage space. Calculate the washbasin without accounting for the Unit. Then add the price of your chosen Unit size.

To view the offered Unit sizes go to page 41.

Side Unit

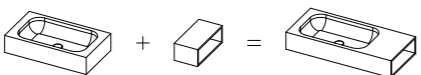

Front Unit



Bottom Unit



Top Unit

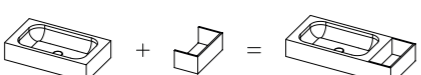

Plateau for Basq tray

To create a plateau (code **XPL**) for the Basq tray, the edge on one or both sides of the washbasin can be lowered.

Calculate the washbasin without accounting for the plateau and then add the cost of code XPL.

The width (w) and height (h) are to be defined by you.

Lower side plateau is calculated per piece, regardless of its width and height

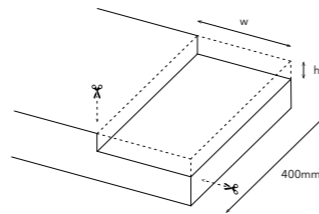

Basq tray

The Basq trays can be ordered in 7mm Natural Oak veneer or 12mm Himacs. See page 125 for all information about the Basq trays.

CBX20040(-NO)
w200 x d400 x h40mm

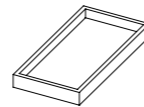

CBX20080(-NO)
w200 x d400 x h80mm

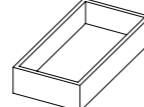

CBX40040(-NO)
w400 x d400 x h40mm

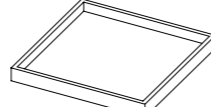

Form plateau

To create a plateau (code **XFP**) in the Form basin on the left or right side of the bowl. Calculate the washbasin without accounting for the plateau and then add the cost of code XFP.

The width (w) is to be defined by you. The height (h) is 25mm and depth (d) is 270mm.

Plateau is calculated per piece, regardless of its width

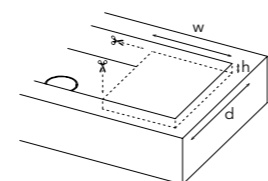

6. Brackets and ribs

Side brackets

When defining the components for a wall-mounted Made to Measure washbasin, Not Only White provides white powder coated steel brackets (code **SB...**) to mount the washbasin to the wall. The rule of thumb is to support the washbasin top approx. every 600 - 800mm.

When installing the brackets, make sure they are positioned as shown in the diagram: thin side up.

We offer brackets for washbasins up to a maximum depth of 520mm in the following lengths:

SB270	bracket length 270mm
SB320	bracket length 320mm
SB370	bracket length 370mm
SB420	bracket length 420mm
SB470	bracket length 470mm

To decide which bracket length is needed, take 30mm off the washbasin depth. The first bracket option below this length is the bracket that will fit your washbasin perfectly.

Brackets are calculated per set of two; it is possible to order per half a set

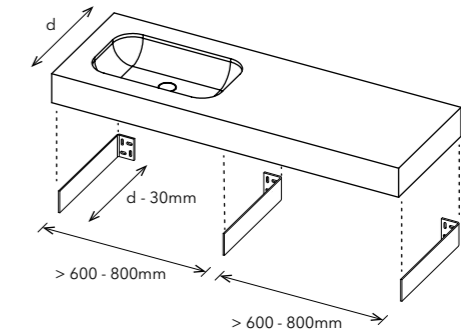

Bowl bracket

In the case a bowl wider than 700mm is being used, we recommend to support the bowl with a white powder coated steel bowl bracket (code **BB...**).

This bowl bracket is additional to the side brackets.

BB330	bracket length 330mm
BB380	bracket length 380mm

To decide which bracket length is needed, take 30mm of the washbasin depth. The first bracket option below this length is the bracket that will fit your washbasin perfectly.

Bowl brackets are calculated per piece

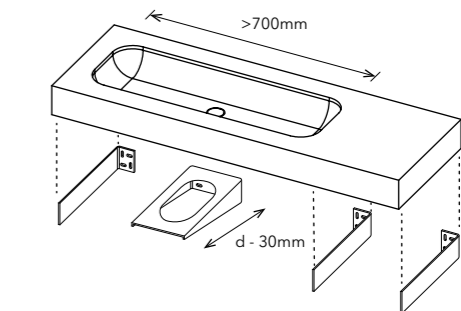

Ribs

When defining the components for a Custom washbasin to be top-mounted on a cabinet or shelf, please take into consideration that ribs, made of plywood, will be needed to properly install the washbasin.

The ribs (code **RIB**) are also positioned underneath the top to strengthen the overall structure of the washbasin. For this purpose, a rib should be placed approx. every 600 - 800mm.

Ribs are calculated per piece

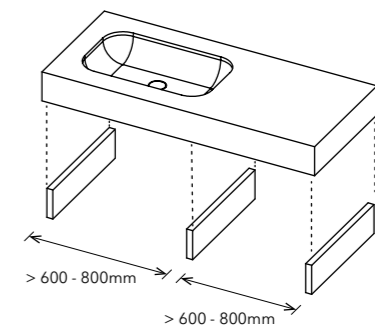



Base



The Base collection consists of basic-shaped basins especially designed for the contract market. It is characterized by the 12mm radius inside the basin. This collection aims to be accessible, adaptable and easy to maintain.

Not only is Base perfect for the domestic environment, but its characteristics also make Base an ideal choice in hygienic surroundings and intensively-used restrooms, such as hospitals, exhibition centers or airports.

Design by Marike Andeweg

○ White Himacs



Washbasin layout

Make a choice between a single or double bowl washbasin and fill in positions 1-5 or 1-6 accordingly. Next step is to define the size of the bowl(s) indicated by the  - symbol. Go to page 24 and 25 for Base bowl sizes.

- SINGLE**
-  bowl size
 - ① max. 5000mm
 - ② max. 550mm
 - ③ min. 35mm
 - ④ min. 30mm
 - ⑤ min. 30mm
min. 50mm with overflow
min. 80mm with tap hole
min. 120mm with tap hole + overflow

Note: when ordering only a top with bowl(s), sizes 3, 4 and 5 need to be adjusted according to the cabinet construction.

- DOUBLE**
-  bowl size
 - ① max. 5000mm
 - ② max. 550mm
 - ③ min. 35mm
 - ④ min. 30mm
 - ⑤ min. 30mm
min. 50mm with overflow
min. 80mm with tap hole
min. 120mm with tap hole + overflow
 - ⑥ min. 50mm

Note: when ordering only a top with bowl(s), sizes 3, 4 and 5 need to be adjusted according to the cabinet construction.

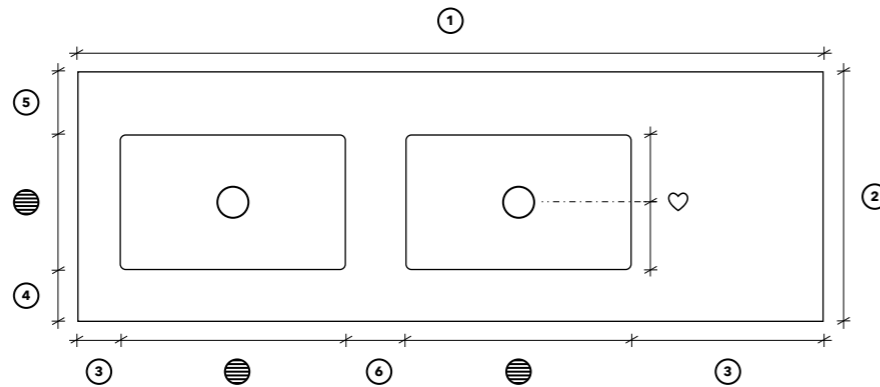
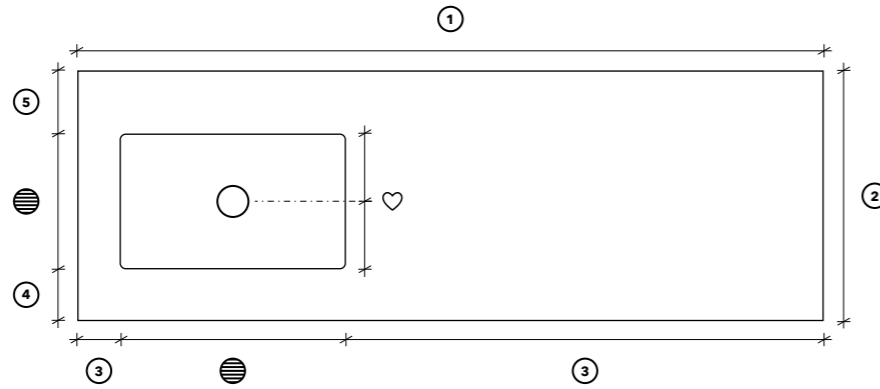

Tap hole

If you need to fit a top-mounted tap, we can pre-drill the hole (code **HH35**).

Consider the space you would need to secure the tap with a tightening ring.

Top-mounted tap without overflow:

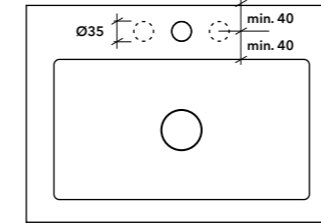

Top-mounted tap with overflow:

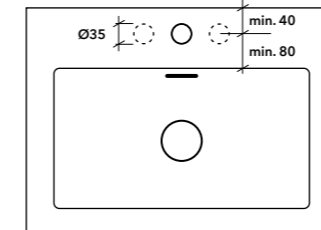

Basq trays

Base washbasin can be supplied with a plateau on the side for Basq trays. Please refer to page 10 and 45.

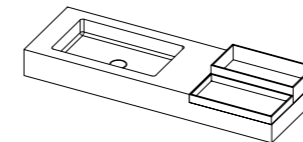

Brackets and ribs

Please refer to page 11, where brackets and ribs are explained, to find out what type of support is needed for your washbasin.

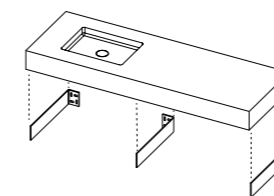

Drain type

Depending on how the washbasin needs to look and work, you can choose from different drain types for Base.

- ① **FLUSH DRAIN**
free flow drain

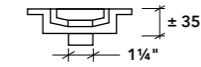

Base bowls are standard equipped with our Flush drain. This drain allows water to flow through at all times and cannot be closed.

Flush drain is free of charge

- ② **POP-DOWN DRAIN**
closable drain

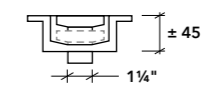

Our Pop-down drain has the same aesthetic as the Flush drain but it can be pressed down to close the drain.

Pop-down drain is calculated per bowl

For use with the Pop-down drain, Not Only White recommends to equip the bowl with an overflow.

- ③ **DR72 DRAIN HOLE**
for a third party drain

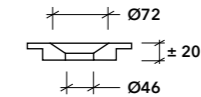

The DR72 drain hole is used for third party drains, both closable and non-closable.

DR72 drain is free of charge

Not Only White recommends to pair a third party closable drain with an overflow.

Note: when choosing a pop-down drain we recommend an overflow and extra edge height of 45mm. With a pop-down drain only we recommend an extra edge height of 15mm.

Overflow

An overflow (code **OH50**) is used for bowls equipped with a closable drain.

The overflow drain tube needs 50mm at the back of the washbasin to fit.

The overflow ring, that drains excess water into the drain, adds 30mm of height underneath the basin drain.

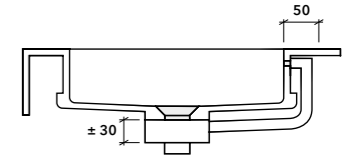

Integrated backsplash

Not Only White offers an integrated backsplash on Base washbasins (code **CSP90H**) with a maximum height of 90mm.

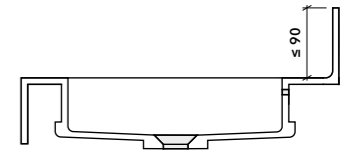

Note that a backsplash with a height over 90mm will be supplied as a separate piece without a radius edge.

Separate backsplash is calculated per m²

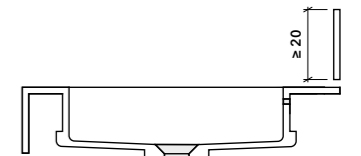

Cut-outs and edge finishes

Please refer to page 10.

Materials and colors

Himacs  White

Edge

Base washbasin can be supplied with a 12mm top or with an edge from 20mm up to 900mm. In order to conceal the bowl, Not Only White recommends an edge height as mentioned on pages 24 and 25 at the 'Bowls' section.

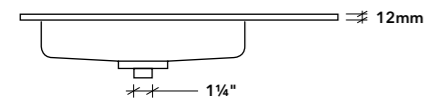

H12
12mm top sheet

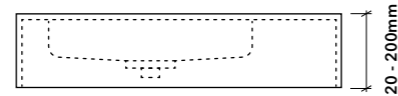

EH100
Edge 20 - 100mm high

EH150
Edge 101 - 150mm high

EH200
Edge 151 - 200mm high

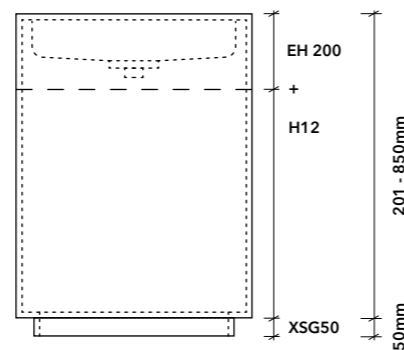

EH200 + remaining m² in H12
Edge 201 - 850mm high

XSG50
50mm plinth for floor-standing model

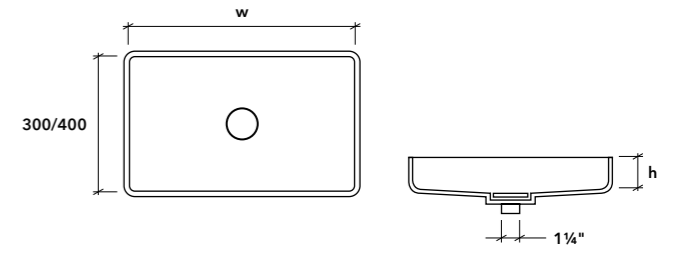
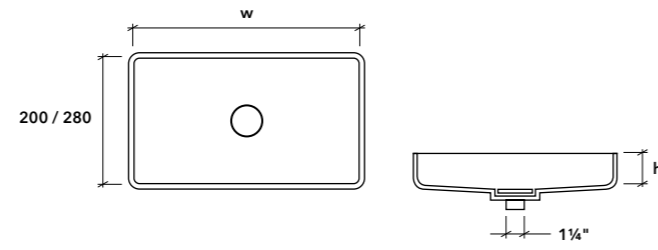

Bowls - 280mm

Bowls - depth 300mm

w400mm x d280mm

w1000mm x d280mm

w400mm x d300mm

w1000mm x d300mm

CBS40285
w400 x d280 x h50mm
rec. edge height 90mm

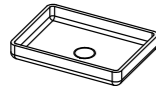

CBS100285
w1000 x d280 x h50mm
rec. edge height 100mm

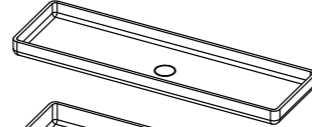

CBS40305
w400 x d300 x h50mm
rec. edge height 90mm

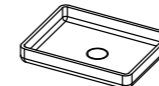

CBS100305
w1000 x d300 x h50mm
rec. edge height 100mm

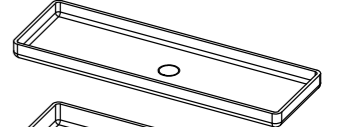

CBS40287
w400 x d280 x h75mm
rec. edge height 115mm

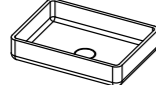

CBS100287
w1000 x d280 x h75mm
rec. edge height 125mm



CBS40307
w400 x d300 x h75mm
rec. edge height 115mm

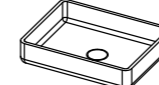

CBS100307
w1000 x d300 x h75mm
rec. edge height 125mm



CBS402810
w400 x d280 x h100mm
rec. edge height 140mm

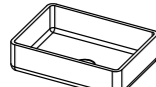

CBS1002810
w1000 x d280 x h100mm
rec. edge height 150mm

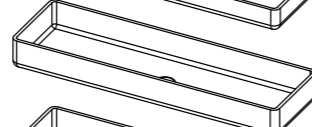

CBS403010
w400 x d300 x h100mm
rec. edge height 140mm



CBS1003010
w1000 x d300 x h100mm
rec. edge height 150mm



CBS402815
w400 x d280 x h150mm
rec. edge height 190mm

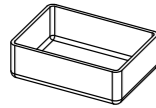

CBS1002815
w1000 x d280 x h150mm
rec. edge height 200mm

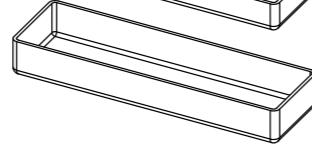

CBS403015
w400 x d300 x h150mm
rec. edge height 190mm

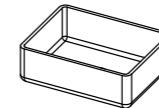

CBS1003015
w1000 x d300 x h150mm
rec. edge height 200mm

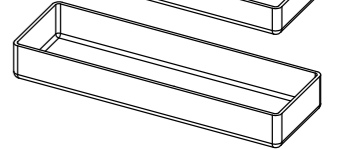

w500mm x d280mm

w500mm x d300mm

CBS50285
w500 x d280 x h50mm
rec. edge height 95mm

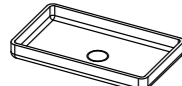

CBS50305
w500 x d300 x h50mm
rec. edge height 95mm

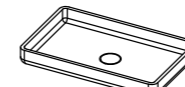

CBS50287
w500 x d280 x h75mm
rec. edge height 120mm



CBS50307
w500 x d300 x h75mm
rec. edge height 120mm

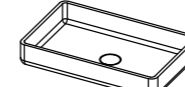

CBS502810
w500 x d280 x h100mm
rec. edge height 145mm

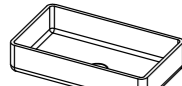

CBS503010
w500 x d300 x h100mm
rec. edge height 145mm



CBS502815
w500 x d280 x h150mm
rec. edge height 195mm

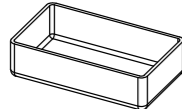

CBS503015
w500 x d300 x h150mm
rec. edge height 195mm

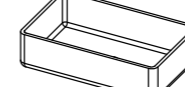

**For basin tops with short projection:
Bowls with depth of only 200mm**

**For basin tops with a deep projection:
Bowls with depth of 400mm**

w800mm x d280mm

w300mm x d200mm

w800mm x d300mm

w400/500/650mm x d400mm

CBS80285
w800 x d280 x h50mm
rec. edge height 100mm

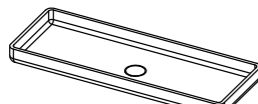

CBS30205
w300 x d200 x h50mm
rec. edge height 90mm

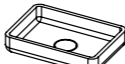

CBS80305
w800 x d300 x h50mm
rec. edge height 100mm

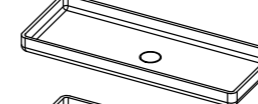

CBS80287
w800 x d280 x h75mm
rec. edge height 125mm



CBS30207
w300 x d200 x h75mm
rec. edge height 115mm



CBS80307
w800 x d300 x h75mm
rec. edge height 125mm



CBS802810
w800 x d280 x h100mm
rec. edge height 150mm

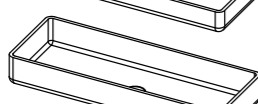

CBS302010
w300 x d200 x h100mm
rec. edge height 140mm

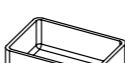

CBS803010
w800 x d300 x h100mm
rec. edge height 150mm



CBS802815
w800 x d280 x h150mm
rec. edge height 200mm



CBS302015
w300 x d200 x h150mm
rec. edge height 190mm



CBS803015
w800 x d300 x h150mm
rec. edge height 200mm



CBS404010
w400 x d400 x h100mm
rec. edge height 140mm

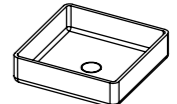

CBS504010
w500 x d400 x h100mm
rec. edge height 145mm

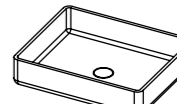

CBS654010
w650 x d400 x h100mm
rec. edge height 150mm

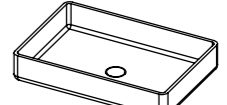



Blend



What makes the Blend collection so special is the fusion of the organic-shaped bowl with the linear top. The invisible design of the Flush drain fits the Blend perfectly. Blend invites you to touch it.

The curved design of the bowl allows for easy maintenance.

Design by Marike Andeweg

○ White Himacs

Washbasin layout

Make a choice between a single or double bowl washbasin and fill in positions 1-5 or 1-6 accordingly. Next step is to define the size of the bowl(s) indicated by the and symbols. Go to page 31 for Blend bowl sizes.

SINGLE

- 473 / 723 / 973mm
- 587 / 837 / 1087mm
- ① max. 5000mm
- ② max. 550mm
- ③ min. 30mm
- ④ min. 30mm
- ⑤ min. 30mm
min. 75mm with tap hole

Note: when ordering only a top with bowl(s), sizes 3, 4 and 5 need to be adjusted according to the cabinet construction.

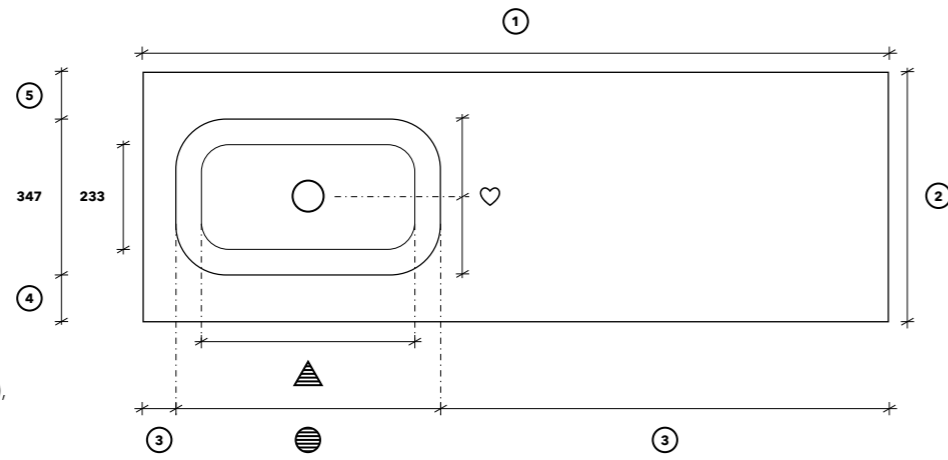

DOUBLE

- 473 / 723 / 973mm
- 587 / 837 / 1087mm
- ① max. 5000mm
- ② max. 550mm
- ③ min. 30mm
- ④ min. 30mm
- ⑤ min. 30mm
min. 75mm with tap hole
- ⑥ min. 60mm

Note: when ordering only a top with bowl(s), sizes 3, 4 and 5 need to be adjusted according to the cabinet construction.

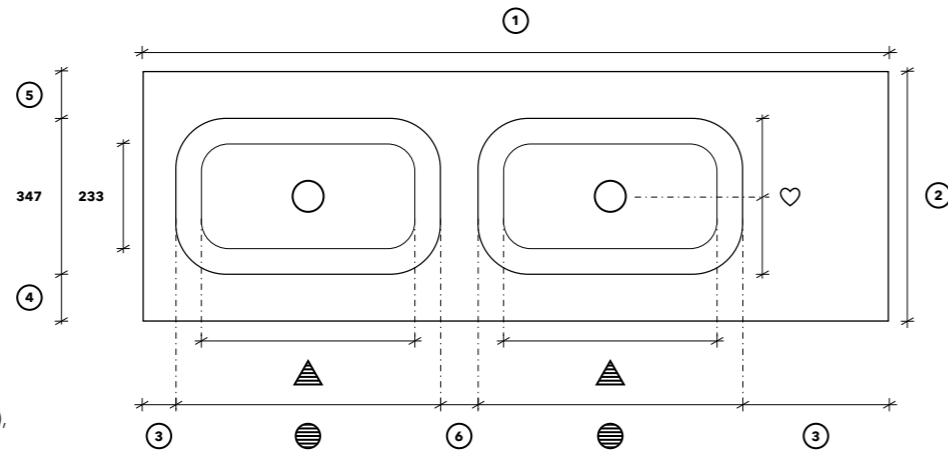

Edge

Blend washbasin can be supplied with a 9mm top or with an edge from 20mm up to 900mm.

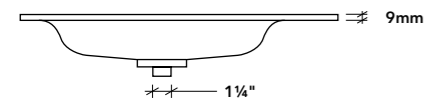

H9
9mm top sheet

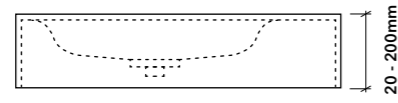

EH100
Edge 20 - 100mm high

EH150
Edge 101 - 150mm high

EH200
Edge 151 - 200mm high

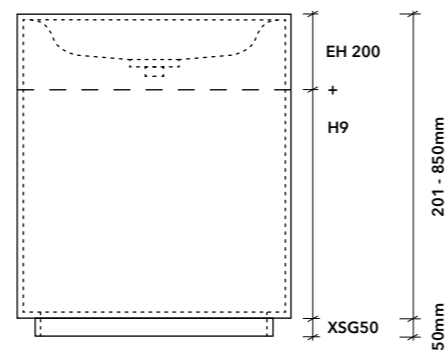

EH200 + remaining m² in H9
Edge 201 - 850mm high

XSG50
50mm plinth for floor-standing model

Bowls

Blend bowls can only be ordered with at least a top.

CBL47390
w587 x d347 x h90mm
rec. edge height 125mm

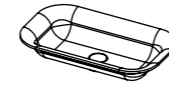

CBL72390
w837 x d347 x h90mm
rec. edge height 125mm

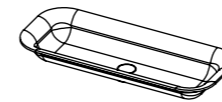

CBL97390
w1087 x d347 x h90mm
rec. edge height 130mm

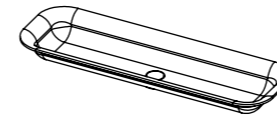

Tap hole

If you need to fit a top-mounted tap, we can pre-drill the hole (code **HH35**).

Consider the space you would need to secure the tap with a tightening ring.

Top-mounted tap:

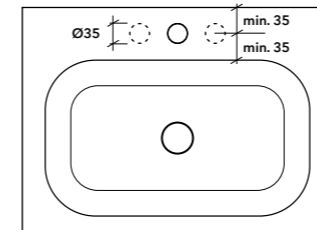

Brackets and ribs

Please refer to page 11, where brackets and ribs are explained, to find out what type of support is needed for your washbasin.

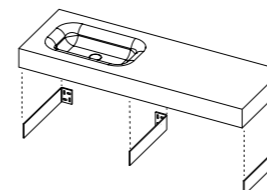

Drain type

Depending on how the washbasin needs to look and work, you can choose from different drain types for Blend.

- ① **FLUSH DRAIN**
free flow drain ± 35
1 1/4"

Blend bowls are standard equipped with our Flush drain. This drain allows water to flow through at all times and cannot be closed.

Flush drain is free of charge

- ② **POP-DOWN DRAIN**
closable drain ± 45
1 1/4"

Our Pop-down drain has the same aesthetic as the Flush drain but it can be pressed down to close the drain.

Pop-down drain is calculated per bowl

For use with the Pop-down drain, Not Only White recommends to equip the bowl with an overflow.

- ③ **DR72 DRAIN HOLE**
for a third party drain Ø72
± 20
Ø46

The DR72 drain hole is used for third party drains, both closable and non-closable.

DR72 drain is free of charge

Not Only White recommends to pair a third party closable drain with an overflow.

Note: when choosing a pop-down drain we recommend an extra edge height of 15mm.

Overflow

An overflow is not possible.

Integrated backsplash

Not Only White offers an integrated backsplash on Base washbasins (code **CSP90H**) with a maximum height of 90mm.

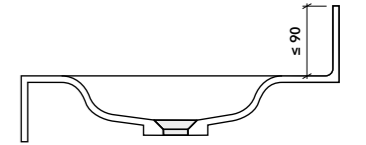

Note that a backsplash with a height over 90mm will be supplied as a separate piece without a radius edge.

Separate backsplash is calculated per m²

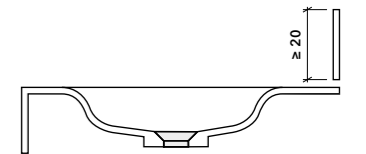

Basq trays

Blend washbasin can be supplied with a plateau on the side for Basq trays. Please refer to page 10 and 45.

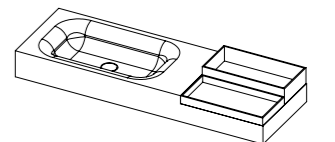

Cut-outs and edge finishes

Please refer to page 10.

Materials and colors

Himacs White



Box



Box collection is the answer to a tidy bathroom. Finally, everyday items like hairbrush and toothpaste have a home of their own. The Natural Oak tray from the Basq collection contrasts with the sleek white Himacs to give a surprising twist to the subtle design. Box is also available in Himacs only without the Basq tray.

Box is defined by a spacious rounded bowl, available in both single and double versions. The seamless round shape allows for easy maintenance.

Design by Marike Andeweg

○ White Himacs



Washbasin layout

Make a choice between a single or double bowl washbasin and fill in positions 1-5 or 1-6 accordingly. Next step is to define the size of the bowl(s) indicated by the - symbol. Go to page 37 for Box bowl sizes.

SINGLE

- 576 / 1076mm
- ① max. 5000mm
- ② max. 550mm
- ③ min. 35mm
- ④ min. 32mm
- ⑤ min. 32mm
min. 50mm with overflow
min. 80mm with tap hole
min. 120mm with tap hole + overflow

Note: when ordering only a top with bowl(s), sizes 3, 4 and 5 need to be adjusted according to the cabinet construction.

DOUBLE

- 576 / 1076mm
- ① max. 5000mm
- ② max. 550mm
- ③ min. 35mm
- ④ min. 32mm
- ⑤ min. 32mm
min. 50mm with overflow
min. 80mm with tap hole
min. 120mm with tap hole + overflow
- ⑥ min. 50mm

Note: when ordering only a top with bowl(s), sizes 3, 4 and 5 need to be adjusted according to the cabinet construction.

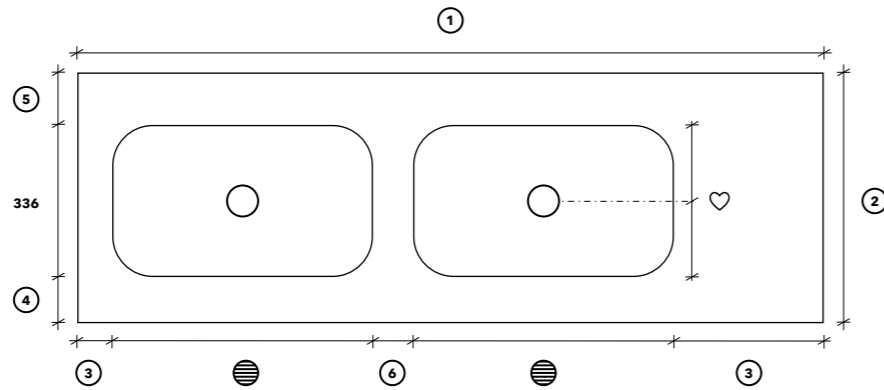
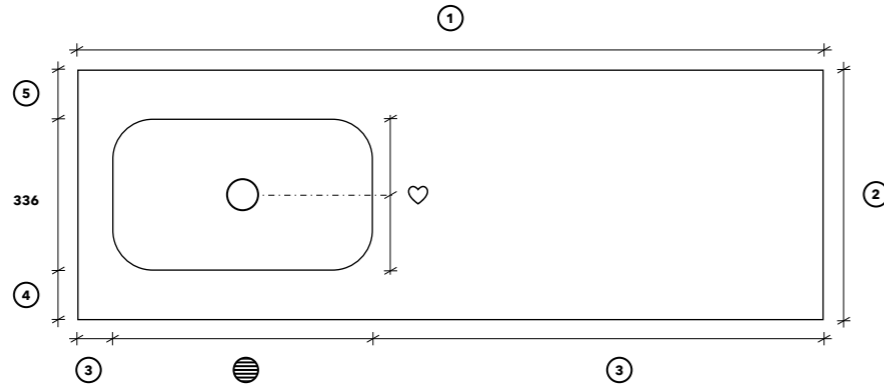

Edge

Box washbasin can be supplied with a 12mm top or with an edge from 20mm up to 900mm.

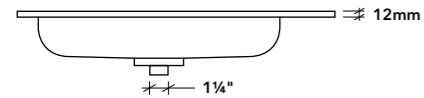

H12
12mm top sheet

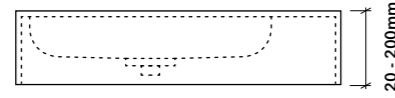

EH100
Edge 20 - 100mm high

EH150
Edge 101 - 150mm high

EH200
Edge 151 - 200mm high

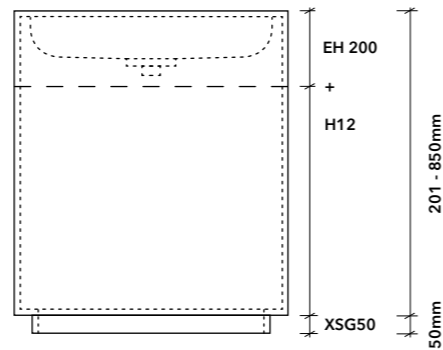

EH200 + remaining m² in H12
Edge 201 - 850mm high

XSG50
50mm plinth for floor-standing model

Bowls

CBX57688
w576 x d336 x h100mm
rec. edge height 135mm

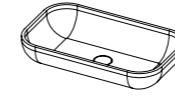

CBX107688
w1076 x d336 x h100mm
rec. edge height 145mm

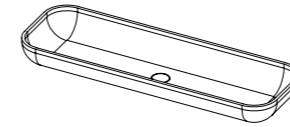

Tap hole

If you need to fit a top-mounted tap, we can pre-drill the hole (code **HH35**).

Consider the space you would need to secure the tap with a tightening ring.

Top-mounted tap without overflow:

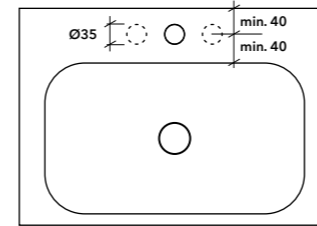

Top-mounted tap with overflow:

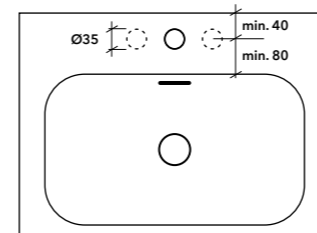

Basq trays

Box washbasin can be supplied with a plateau on the side for Basq trays. Please refer to page 10 and 45.

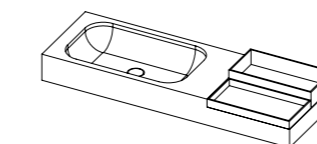

Drain type

Depending on how the washbasin needs to look and work, you can choose from different drain types for Box.

- ① **FLUSH DRAIN**
free flow drain

Box bowls are standard equipped with our Flush drain. This drain allows water to flow through at all times and cannot be closed.

Flush drain is free of charge

- ② **POP-DOWN DRAIN**
closable drain

Our Pop-down drain has the same aesthetic as the Flush drain but it can be pressed down to close the drain.

Pop-down drain is calculated per bowl

For use with the Pop-down drain, Not Only White recommends to equip the bowl with an overflow.

- ③ **DR72 DRAIN HOLE**
for a third party drain

The DR72 drain hole is used for third party drains, both closable and non-closable.

DR72 drain is free of charge

Not Only White recommends to pair a third party closable drain with an overflow.

Note: when choosing a pop-down drain we recommend an overflow and extra edge height of 45mm. With a pop-down drain only we recommend an extra edge height of 15mm.

Cut-outs and edge finishes

Please refer to page 10.

Materials and colors

- Himacs White

Brackets and ribs

Please refer to page 11, where brackets and ribs are explained, to find out what type of support is needed for your washbasin.

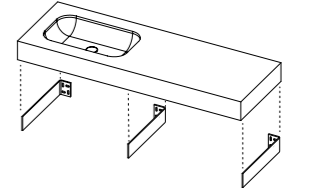

Overflow

An overflow (code **OH50**) is used for bowls equipped with a closable drain.

The overflow drain tube needs 50mm at the back of the washbasin to fit.

The overflow ring, that drains excess water into the drain, adds 30mm of height underneath the basin drain.

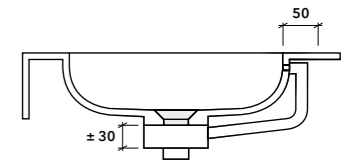

Integrated backsplash

Not Only White offers an integrated backsplash on Base washbasins (code **CSP90H**) with a maximum height of 90mm.

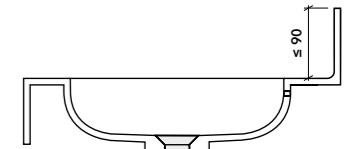

Note that a backsplash with a height over 90mm will be supplied as a separate piece without a radius edge.

Separate backsplash is calculated per m²

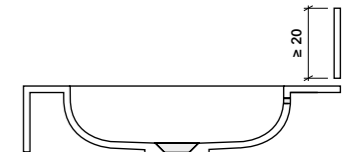



Form



The Form's linearity gives the collection its signature clean and serene look. The rounded Flush drain, however, punctuates all the straight lines in a surprising and yet pleasing manner.

Next to the basin a lower plateau can be integrated to create a platform for a mounted tap or a space to place soap or other bathroom accessories.

Design by Marike Andeweg

○ White Himacs



Washbasin layout

Make a choice between a single or double bowl washbasin and fill in positions 1-5 or 1-6 accordingly. Next step is to define the size of the bowl(s) indicated by the - symbol. Go to page 46 for Form bowl sizes.

SINGLE

- bowl width
- ① max. 5000mm
- ② max. 550mm
- ③ min. 35mm
- ④ min. 30mm
- ⑤ min. 30mm
min. 50mm with overflow
min. 80mm with tap hole
min. 120mm with tap hole + overflow

Note: when ordering only a top with bowl(s), sizes 3, 4 and 5 need to be adjusted according to the cabinet construction.

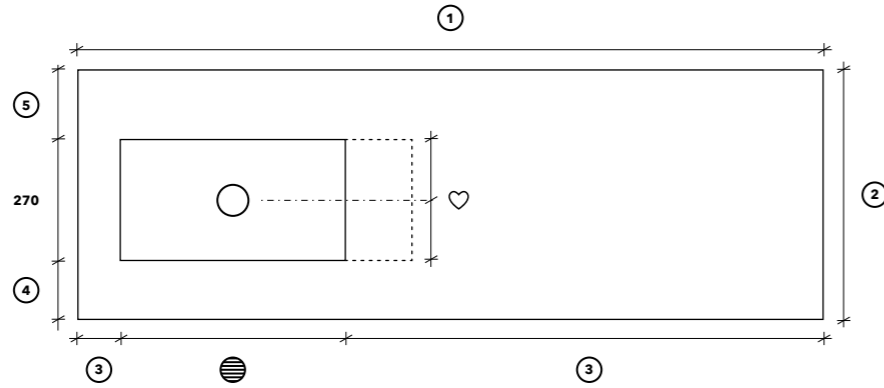

DOUBLE

- bowl width
- ① max. 5000mm
- ② max. 500mm
- ③ min. 35mm
- ④ min. 30mm
- ⑤ min. 30mm
min. 50mm with overflow
min. 80mm with tap hole
min. 120mm with tap hole + overflow
- ⑥ min. 50mm

Note: when ordering only a top with bowl(s), sizes 3, 4 and 5 need to be adjusted according to the cabinet construction.

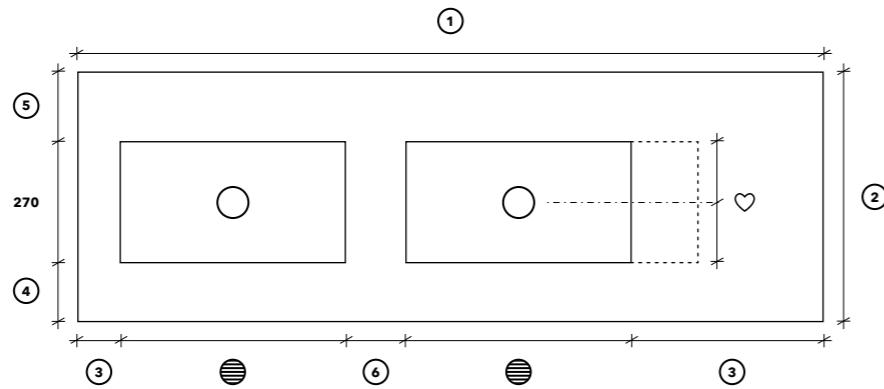

Edge

Form washbasin can be supplied with a 12mm top or with an edge from 20mm up to 900mm. In order to conceal the bowl, Not Only White recommends an edge height as mentioned on page 46 at the 'Bowls' section.

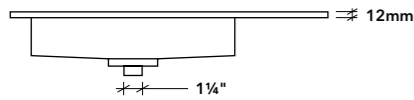

H12
12mm top sheet

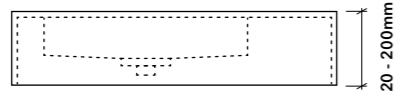

EH100
Edge 20 - 100mm high

EH150
Edge 101 - 150mm high

EH200
Edge 151 - 200mm high

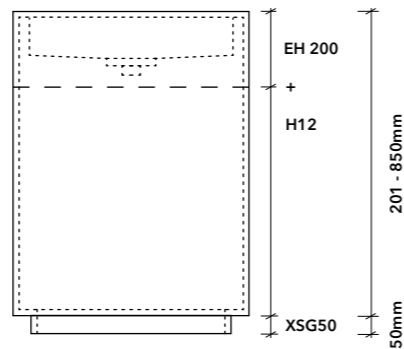

EH200 + remaining m² in H12
Edge 201 - 850mm high

XSG50
50mm plinth for floor-standing model

Tap hole

If you need to fit a top-mounted tap, we can pre-drill the hole (code **HH35**).

Consider the space you would need to secure the tap with a tightening ring.

Top-mounted tap without overflow:

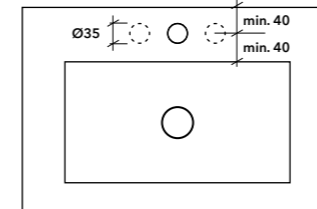

Top-mounted tap with overflow:

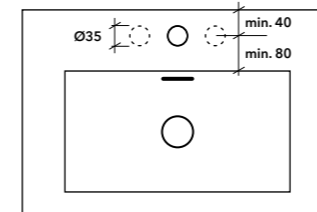

Basq trays

Form washbasin can be supplied with a plateau on the side for Basq trays. Please refer to page 10 and 45.

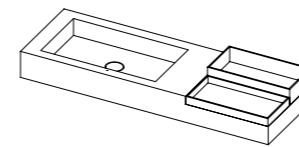

Cut-outs and edge finishes

Please refer to page 10.

Form plateau

Form can be delivered with a plateau next to right or the left side of the bowl. Please refer to page 10.

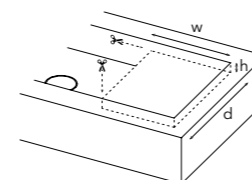

Drain type

Depending on how the washbasin needs to look and work you can choose from different drain types for Form.

- ① **FLUSH DRAIN**
free flow drain

Form bowls are standard equipped with our Flush drain. This drain allows water to flow through at all times and cannot be closed.

Flush drain is free of charge

- ② **POP-DOWN DRAIN**
closable drain

Our Pop-down drain has the same aesthetic as the Flush drain but it can be pressed down to close the drain.

Pop-down drain is calculated per bowl

For use with the Pop-down drain, Not Only White recommends to equip the bowl with an overflow.

- ③ **DR72 DRAIN HOLE**
for a third party drain

The DR72 drain hole is used for third party drains, both closable and non-closable.

DR72 drain is free of charge

Not Only White recommends to pair a third party closable drain with an overflow.

Note: when choosing a pop-down drain we recommend an overflow and extra edge height of 45mm. With a pop-down drain only we recommend an extra edge height of 15mm.

Brackets and ribs

Please refer to page 11, where brackets and ribs are explained, to find out what type of support is needed for your washbasin.

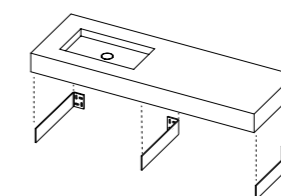

Overflow

An overflow (code **OH50**) is used for bowls equipped with a closable drain.

The overflow drain tube needs 50mm at the back of the washbasin to fit.

The overflow ring, that drains excess water into the drain, adds 30mm of height underneath the basin drain.

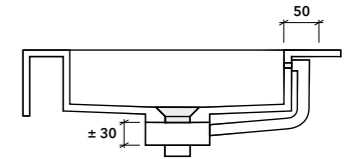

Integrated backsplash

Not Only White offers an integrated backsplash on Form washbasins (code **CSP90H**) with a maximum height of 90mm.

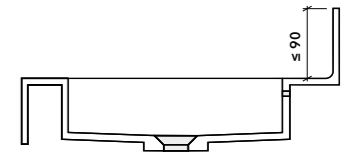

Note that a backsplash with a height over 90mm will be supplied as a separate piece without a radius edge.

Separate backsplash is calculated per m²

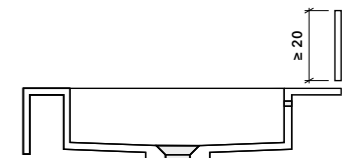

Materials and colors

Himacs White

Form

Form Custom Made

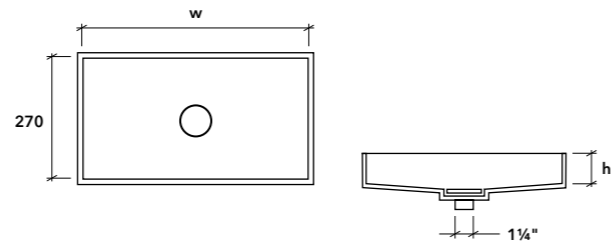

Bowls - depth 270mm

Form bowls can only be ordered with at least a top

w270mm

CFM27050
w270 x d270 x h50mm
rec. edge height 90mm

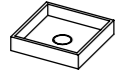

CFM27075
w270 x d270 x h75mm
rec. edge height 115mm

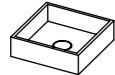

CFM270100
w270 x d270 x h100mm
rec. edge height 140mm



w500mm

CFM50050
w500 x d270 x h50mm
rec. edge height 95mm

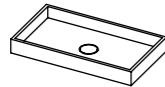

CFM50075
w500 x d270 x h75mm
rec. edge height 120mm

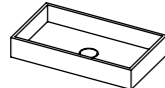

CFM500100
w500 x d270 x h100mm
rec. edge height 145mm

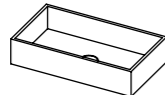

w1000mm

CFM100050
w1000 x d270 x h100mm
rec. edge height 95mm

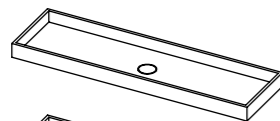

CFM100075
w1000 x d270 x h75mm
rec. edge height 125mm



CFM1000100
w1000 x d270 x h100mm
rec. edge height 150mm

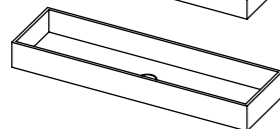



Mono



The Mono collection arised from one beautifully oval shaped bowl. Its organic form draws you into the bowl, ready to freshen up. The linear top gives the Mono a timeless modern look and feel. This collection is suitable for many types of projects. It just feels right at home, in an office or a hotel.

Design by Marike Andeweg

○ White Himacs



Washbasin layout

Make a choice between a single or double bowl washbasin and fill in positions 1-5 or 1-6 accordingly.

SINGLE

- w450 x d300 mm
- ① max. 5000mm
- ② max. 550mm
- ③ min. 35mm
- ④ min. 30mm
- ⑤ min. 30mm
min. 50mm with overflow
min. 80mm with tap hole
min. 120mm with tap hole + overflow

Note: when ordering only a top with bowl(s), sizes 3, 4 and 5 need to be adjusted according to the cabinet construction.

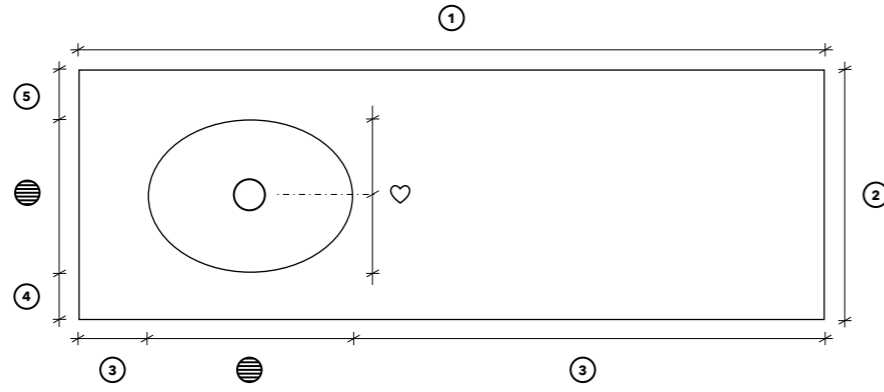

DOUBLE

- w450 x d300 mm
- ① max. 5000mm
- ② max. 550mm
- ③ min. 35mm
- ④ min. 30mm
- ⑤ min. 30mm
min. 50mm with overflow
min. 80mm with tap hole
min. 120mm with tap hole + overflow
- ⑥ min. 50mm

Note: when ordering only a top with bowl(s), sizes 3, 4 and 5 need to be adjusted according to the cabinet construction.

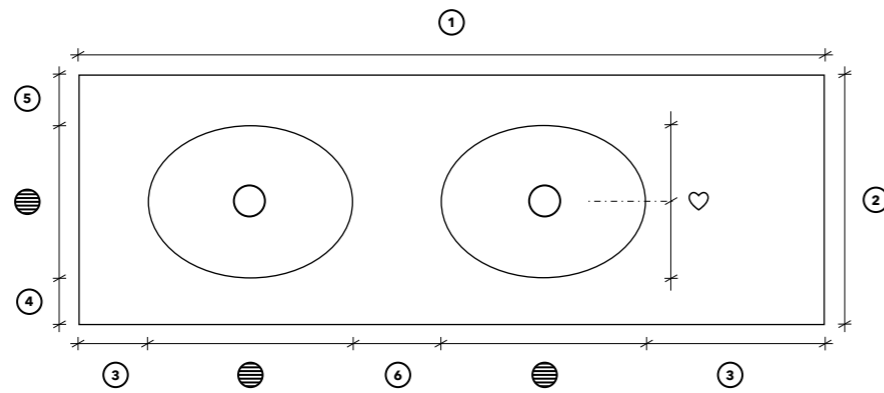

Edge

Mono washbasin can be supplied with a 12mm top or with an edge from 20mm up to 900mm.

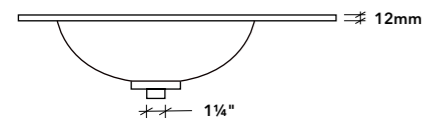

H12
12mm top sheet

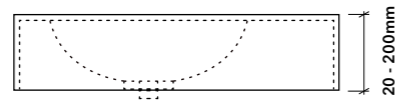

EH100
Edge 20 - 100mm high

EH150
Edge 101 - 150mm high

EH200
Edge 151 - 200mm high

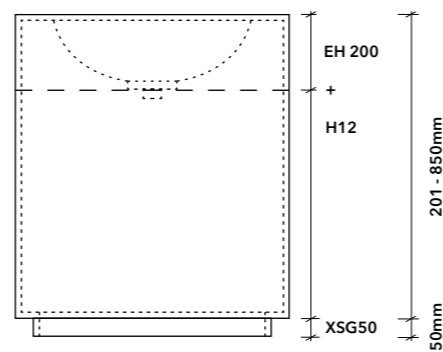

EH200 + remaining m² in H12
Edge 201 - 850mm high

XSG50
50mm plinth for floor-standing model

Bowls

The Mono bowl can only be ordered with at least a top.

CMO450
w450 x d300 x h120mm
rec. edge height 135 mm



Tap hole

If you need to fit a top-mounted tap, we can pre-drill the hole (code HH35).

Consider the space you would need to secure the tap with a tightening ring.

Top-mounted tap without overflow:

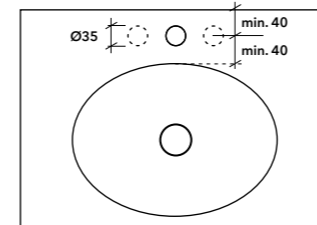

Top-mounted tap with overflow:

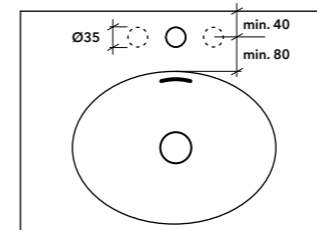

Cut-outs and edge finishes

Please refer to page 10.

Materials and colors

Himacs ○ White

Drain type

Depending on how the washbasin needs to look and work, you can choose from different drain types for Mono.

- ① **FLUSH DRAIN**
free flow drain

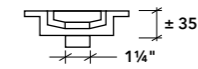

Mono bowls are standard equipped with our Flush drain. This drain allows water to flow through at all times and cannot be closed.

Flush drain is free of charge

- ② **POP-DOWN DRAIN**
closable drain

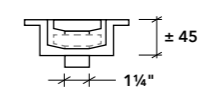

Our Pop-down drain has the same aesthetic as the Flush drain but it can be pressed down to close the drain.

Pop-down drain is calculated per bowl

For use with the Pop-down drain, Not Only White recommends to equip the bowl with an overflow.

- ③ **DR72 DRAIN HOLE**
for a third party drain

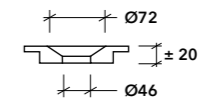

The DR72 drain hole is used for third party drains, both closable and non-closable.

DR72 drain is free of charge

Not Only White recommends to pair a third party closable drain with an overflow.

Note: when choosing a pop-down drain we recommend an overflow and extra edge height of 45mm. With a pop-down drain only we recommend an extra edge height of 15mm.

Basq trays

Mono washbasin can be supplied with a plateau on the side for Basq trays. Please refer to page 10 and 45.

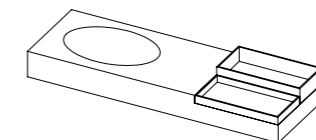

Overflow

An overflow (code OH50) is used for bowls equipped with a closable drain.

The overflow drain tube needs 50mm at the back of the washbasin to fit.

The overflow ring, that drains excess water into the drain, adds 30mm of height underneath the basin drain.

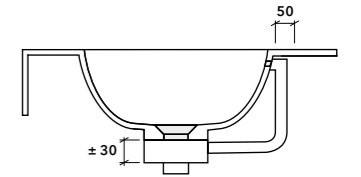

Integrated backsplash

Not Only White offers an integrated backsplash on Base washbasins (code CSP90H) with a maximum height of 90mm.

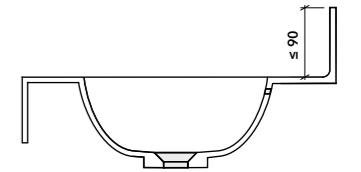

Note that a backsplash with a height over 90mm will be supplied as a separate piece without a radius edge.

Separate backsplash is calculated per m²

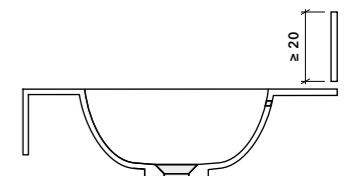

Brackets and ribs

Please refer to page 11, where brackets and ribs are explained, to find out what type of support is needed for your washbasin.

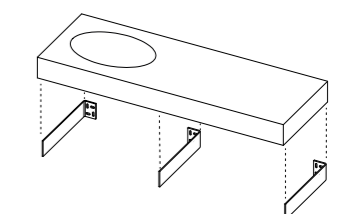



Noon



The combination of the spacious round bowl and straight outlines of the top gives Noon its friendly and appealing appearance. Whether at home or in a luxurious hotel, using Noon washbasin is the perfect way to start or end your day.

Noon is a versatile collection which is reflected in the many options ranging from countertop bowls, undermounted and a handrinse collection.

Design by Marike Andeweg

○ White Himacs



Washbasin layout

Make a choice between a single or double bowl washbasin and fill in positions 1-5 or 1-6 accordingly.
Next step is to define the size of the bowl(s) indicated by the - symbol. Go to page 77 for Noon bowl sizes.

SINGLE

- 340 / 400 / 460mm
- ① max. 5000mm
- ② max. 550mm
- ③ min. 35mm
- ④ min. 30mm
- ⑤ min. 30mm
min. 50mm with overflow
min. 80mm with tap hole
min. 120mm with tap hole + overflow

Note: when ordering only a top with bowl(s), sizes 3, 4 and 5 need to be adjusted according to the cabinet construction.

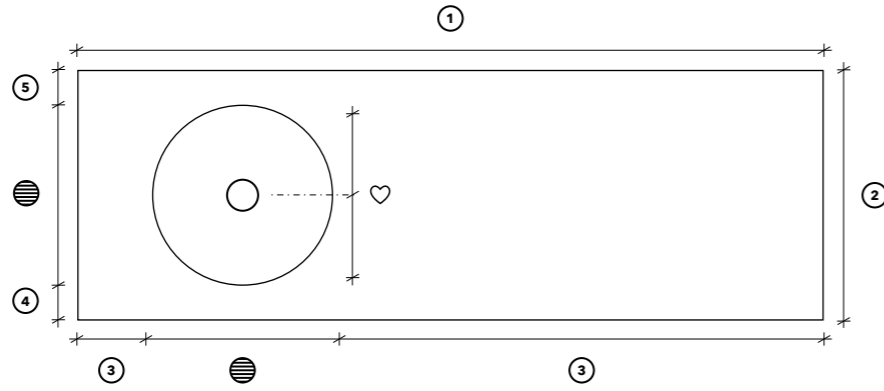

DOUBLE

- 340 / 400 / 460mm
- ① max. 5000mm
- ② max. 550mm
- ③ min. 35mm
- ④ min. 30mm
- ⑤ min. 30mm
min. 50mm with overflow
min. 80mm with tap hole
min. 120mm with tap hole + overflow
- ⑥ min. 50mm

Note: when ordering only a top with bowl(s), sizes 3, 4 and 5 need to be adjusted according to the cabinet construction.

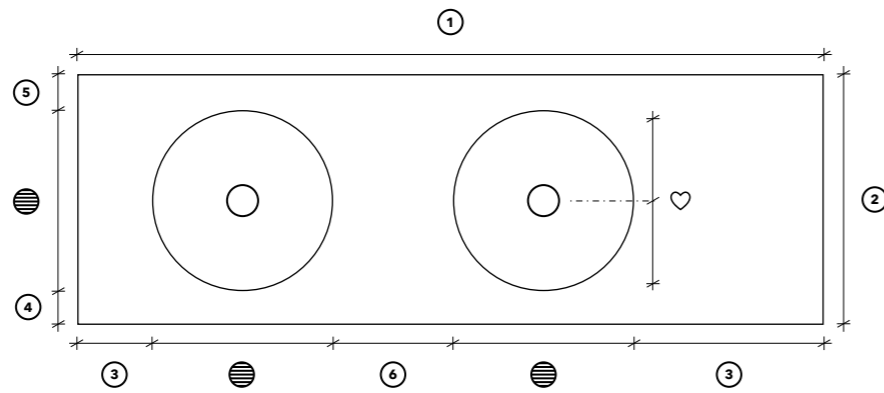

Edge

Noon washbasin can be supplied with a 12mm top or with an edge from 20mm up to 900mm.

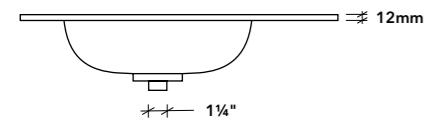

H12
12mm top sheet

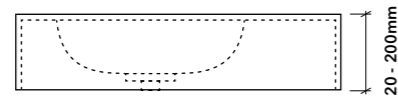

EH100
Edge 20 - 100mm high

EH150
Edge 101 - 150mm high

EH200
Edge 151 - 200mm high

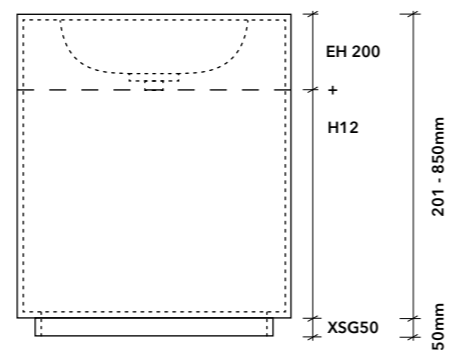

EH200 + remaining m² in H12
Edge 201 - 850mm high

XSG50
50mm plinth for floor-standing model

Bowls

CNN340
Ø340 x h114mm
rec. edge height 150mm



CNN400
Ø400 x h124mm
rec. edge height 160mm



CNN460
Ø460 x h134mm
rec. edge height 170mm



Tap hole

If you need to fit a top-mounted tap, we can pre-drill the hole (code **HH35**).

Consider the space you would need to secure the tap with a tightening ring.

Top-mounted tap without overflow:

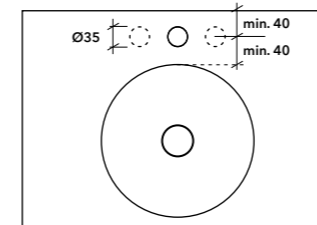

Top-mounted tap with overflow:

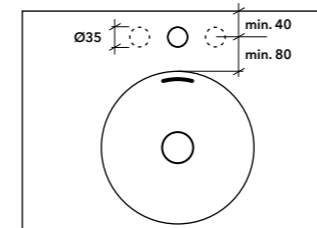

Cut-outs and edge finishes

Please refer to page 10.

Drain type

Depending on how the washbasin needs to look and work, you can choose from different drain types for Noon.

- ① **FLUSH DRAIN**
free flow drain

Noon bowls are standard equipped with our Flush drain. This drain allows water to flow through at all times and cannot be closed.

Flush drain is free of charge

- ② **POP-DOWN DRAIN**
closable drain

Our Pop-down drain has the same aesthetic as the Flush drain but it can be pressed down to close the drain.

Pop-down drain is calculated per bowl

For use with the Pop-down drain, Not Only White recommends to equip the bowl with an overflow.

- ③ **DR72 DRAIN HOLE**
for a third party drain

The DR72 drain hole is used for third party drains, both closable and non-closable.

DR72 drain is free of charge

Not Only White recommends to pair a third party closable drain with an overflow.

Note: when choosing a pop-down drain we recommend an overflow and extra edge height of 45mm. With a pop-down drain only we recommend an extra edge height of 15mm.

Basq trays

Noon washbasin can be supplied with a plateau on the side for Basq trays. Please refer to page 10 and 45.

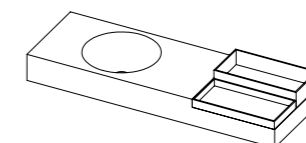

Overflow

An overflow (code **OH50**) is used for bowls equipped with a closable drain.

The overflow drain tube needs 50mm at the back of the washbasin to fit.

The overflow ring, that drains excess water into the drain, adds 30mm of height underneath the basin drain.

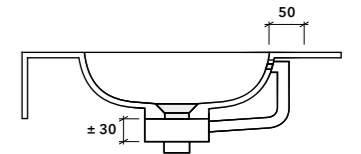

Integrated backsplash

Not Only White offers an integrated backsplash on Base washbasins (code **CSP90H**) with a maximum height of 90mm.

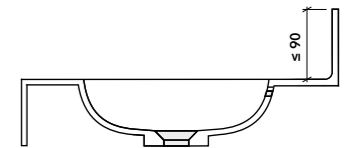

Note that a backsplash with a height over 90mm will be supplied as a separate piece without a radius edge.

Separate backsplash is calculated per m²

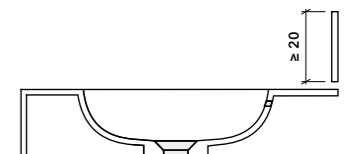

Brackets and ribs

Please refer to page 11, where brackets and ribs are explained, to find out what type of support is needed for your washbasin.

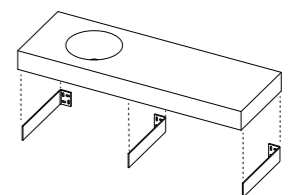

Materials and colors

Himacs White

Unit cabinet



The Unit storage space is created to compliment all of our Himacs basins and Flat shelf by integrating much-welcomed extra storage space into the designs without compromising their simple aesthetics.

Unit is available as front, side, top and bottom storage space.

Design by Marike Andeweg

White Himacs

Specifications

- seamlessly integrated
- including mounting hole(s)

Side Unit

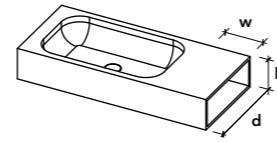
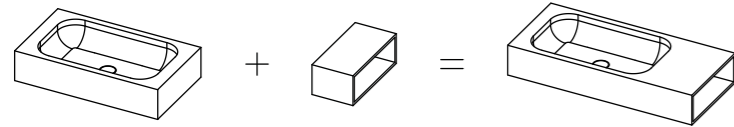

d140 - 260mm

d261 - 450mm

CSIU302630
w100 - 300mm
w 100 - 300mm
d 140 - 260mm
h 150 - 300mm

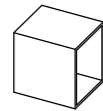

CSIU304530
w100 - 300mm
w 100 - 300mm
d 261 - 450mm
h 150 - 300mm

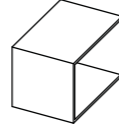

Front Unit

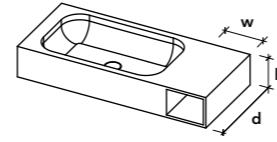
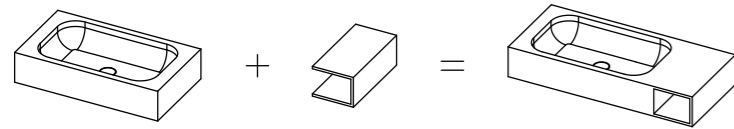

d140 - 260mm

d261 - 450mm

CFRU302630
w100 - 300mm
w 100 - 300mm
d 140 - 260mm
h 150 - 300mm

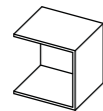

CFRU304530
w100 - 300mm
w 100 - 300mm
d 261 - 450mm
h 150 - 300mm

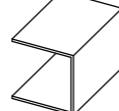

CFRU602630
w301 - 600mm
w 301 - 600mm
d 140 - 260mm
h 150 - 300mm

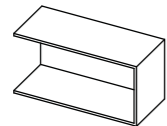

CFRU604530
w301 - 600mm
w 301 - 600mm
d 261 - 450mm
h 150 - 300mm

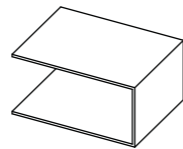

Specifications

- seamlessly integrated
- including mounting hole(s) for bottom unit

Top Unit

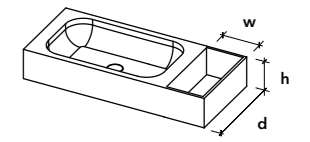
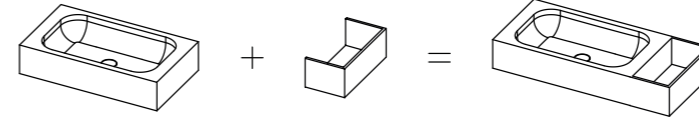

d140 - 260mm

d261 - 450mm

CTPU302630
w300 - 700mm
w 100 - 300mm
d 140 - 260mm
h 150 - 300mm



CTPU304530
w300 - 700mm
w 100 - 300mm
d 261 - 450mm
h 150 - 300mm

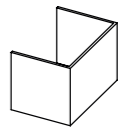

Bottom Unit

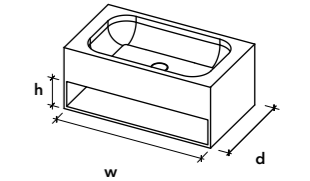
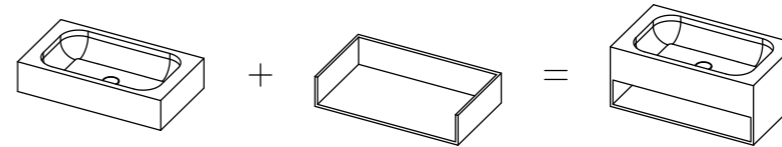

d140 - 260mm

d261 - 450mm

CBTU702630
w300 - 700mm
w 300 - 700mm
d 140 - 260mm
h 150 - 300mm

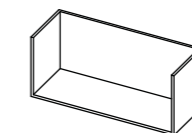

CBTU704530
w300 - 700mm
w 300 - 700mm
d 261 - 450mm
h 150 - 300mm

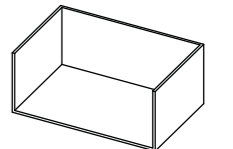

Basq tray

Besides Natural Oak, Basq trays are also available in different Himacs colors.

Though a natural complement to the Box washbasin, the Basq trays can also be combined with all other Not Only White washbasins and Flat shelf in Himacs.

Design by Marike Andeweg



Basq tray Models

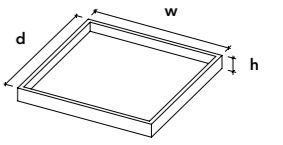

Specifications

- Basq trays can be combined with Base, Blend, Box, Form, Kuub, Mono, Noon washbasins and Flat shelves with a lower side plateau by using code XPL

	Himacs 12mm		Oak veneer 7mm
CBX20040 w200 x d400 x h40mm		CBX20040-NO w200 x d400 x h40mm	
CBX20080 w200 x d400 x h80mm		CBX20080-NO w200 x d400 x h80mm	
CBX40040 w400 x d400 x h40mm		CBX40040-NO w400 x d400 x h40mm	

Plateau for Basq tray

To create a plateau (code **XPL**) for the Basq tray, the edge on one or both sides of the washbasin can be lowered.

Calculate the washbasin without accounting for the plateau and then add the cost of code XPL.

The width (w) and height (h) are to be defined by you.

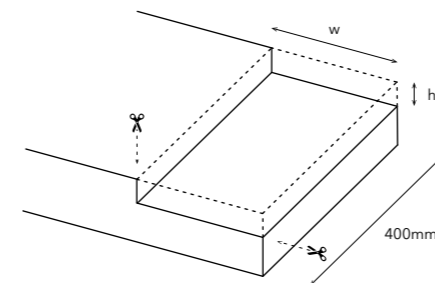

Materials and colors

Himacs

- White
- Grey
- Concrete

Oak veneer

- Natural Oak

Flat shelves are an integral part of the Not Only White collection.

By using a customised shelf underneath or just next to your washbasin, you can easily create extra storage space. Ambiance can be personalized instantaneously by changing accessories placed on the shelf, such as towels and small storage boxes.

Design by Marike Andeweg

Shelf layout

Fill in positions 1-2.

- ① max. 5000mm
- ② max. 550mm



Edge

Flat shelf can be supplied with an edge from 20mm up to 900mm. In order to keep our brackets out of sight, Not Only White recommends an edge height of 85mm.

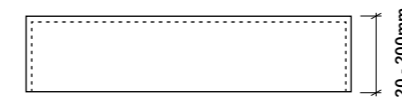

EH100
Edge 20 - 100mm high

EH150
Edge 101 - 150mm high

EH200
Edge 151 - 200mm high

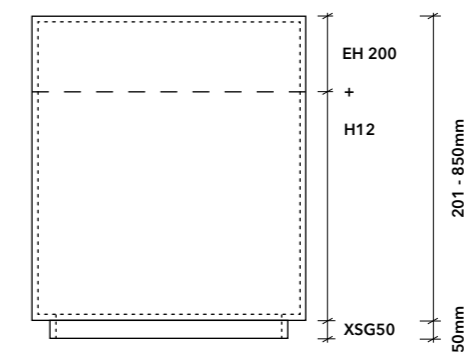

EH200 + remaining m² in H12
Edge 201 - 850mm high

XSG50
50mm plinth for floor-standing model

Holes

In the case of a top-mounted tap, Not Only White can pre-drill tap holes (code **HH35**).

In the case of a countertop bowl, Not Only White can pre-drill a hole for the drain (code **HH70**).

In the case of a semi-recessed Noon bowl in Flat shelf, Not Only White can pre-mill a hole (code **HH170**).

Brackets and ribs

Please refer to page 11, where brackets and ribs are explained, to find out what type of support is needed for your washbasin.

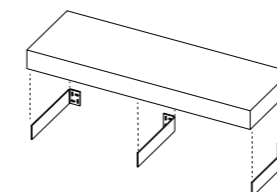

Materials and colors

- Himacs**
- White
 - Grey

Basq trays

Flat shelf can be supplied with a plateau on the side for Basq trays. Please refer to page 10 and 45.

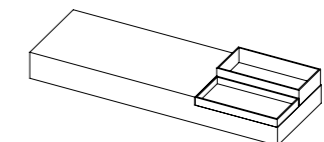



Aim



Tasked with the brief of reinterpreting nostalgia in a contemporary context, Dutch designer Joost van der Vecht studied the characteristics of basin design throughout the last century, with the result being the Aim washbasin.

The essential edge detail on the outside anchors the sleekness of the overall look. The inside of the bowl is soft and rounded which is extended into detail in the almost invisible vaulting of the overflow. In order to accentuate the fluidity in the finer details, solid surface material Velluto® was chosen for Aim. The black Soft Touch coating creates tactility and interest to the base of the bowl, a design element which is often hidden.

Design by Joost van der Vecht

● White Velluto® biobased with black Soft Touch coating

Aim

Aim Models

Specifications

- with closable click-clack waste kit with Velluto® drain cover and integrated overflow
- including Fischer bolt set for wall-mounting
- tap hole(s) have to be drilled by a professional installer
- with Soft Touch coating and towel rack in custom RAL color possible for projects from 20 pieces

AIMST03-BL
w1000 x d420 x h173mm
Soft Touch coating RAL 9005

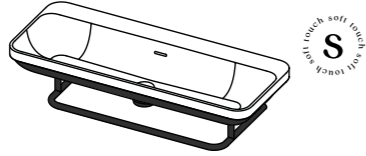

Materials and colors

Velluto® biobased

- White with Soft Touch coating RAL 9005
- with Soft Touch coating in custom RAL color possible for projects from 20 pieces

Steel

- powder coating RAL 9005
- powder coating in custom RAL color possible for projects from 20 pieces

Mounting

Side view

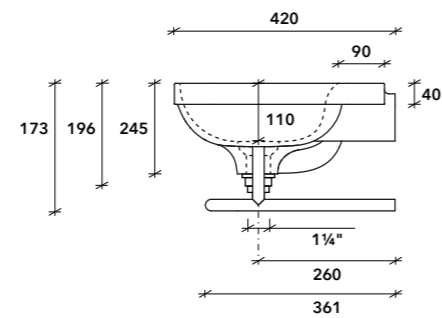

Back view

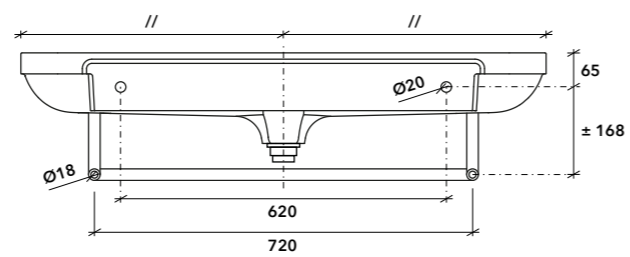



Specifications

- delivered with our Flush drain
- Box countertop bowl should be fixed on top of a surface using flexible silicon

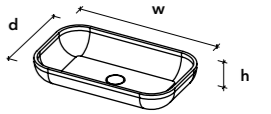

FBXT01
w600 x d360 x h123mm
12mm material thickness

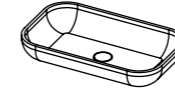

FBXT03
w1100 x d360 x h123mm
12mm material thickness

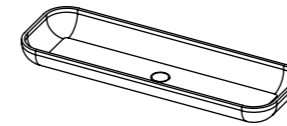

Materials and colors

Himacs White

Drain type

Box countertop is delivered with matching free flow Himacs Flush drain. See drawing below.

The basin can also be equipped with our closable Pop-down drain.

Front view

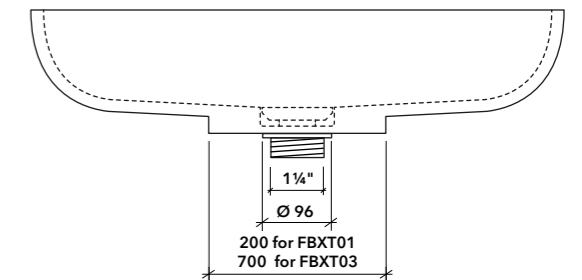

Side view

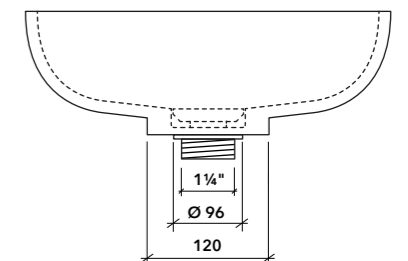

Box countertop bowl is defined by a spacious rounded shape, available in a single and double version. Maintenance is a breeze as the ancillary foot allows easy access to and around the base. Box is supplied with our Flush drain as standard.

Box can be combined with our Flat shelf or with a cabinet.

Design by Marike Andeweg



Fall



Generous volumes in soft hues characterize Fall collection by designer Joost van der Vecht. A series of 3 countertop models, where the need for space determines the choice.

The concept is based on a play with height. Fall comes in a height of 180mm, 270mm and 360mm. The high Fall basin of 360mm will naturally be placed on a shelf closer to the floor which results in a nifty volume next to basin for accessories.

Fall has a soft minimalist appearance due to its straight lines combined with the smooth color tints of Himacs like Sea Oat Quartz, Peanut Butter and White Quartz.

Design by Joost van der Vecht

- White Himacs
- White Quartz Himacs
- Sea Oat Quartz Himacs
- Peanut Butter Himacs

Fall

Fall Models

Specifications

- with 5mm slot drain
- removable inlay for cleaning
- countertop model
- delivered in White, White Quartz, Sea Oat Quartz and Peanut Butter Himacs

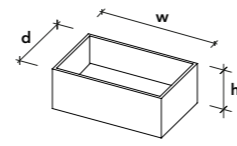

w480mm

FFA01
w480 x d300 x h180mm
inlay 120mm down from top

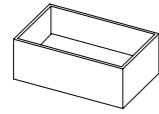

FFA02
w480 x d300 x h270mm
inlay 180mm down from top

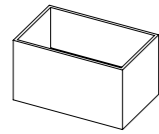

FFA03
w480 x d300 x h360mm
inlay 240mm down from top

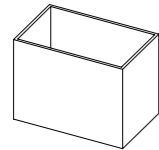

Materials and colors

Himacs



White



Sea Oat Quartz



White Quartz



Peanut Butter



Frame



The open structure of the Frame collection literally frames and reveals the shape of the basin above. This partnership is best expressed when paired with the Blend whereby the straight line of the metal Frame is contrasted with the sinuous underside of the basin.

The Frame offers sufficient storage space yet at the same time stays transparent and unobtrusive. The shelf is made of 9mm Himacs.

Design by Marike Andeweg

- White Himacs
- White powder coated steel

Frame

Frame Models

Specifications

- delivered with our Flush drain
- delivered including white powder coated steel frame and white Himacs bottom shelf
- the position of the bowl can be changed on demand
- Any RAL color possible for the frame for projects from 20 pieces

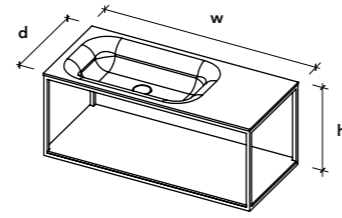

FFRB02
w900 x d400 x h370mm
bowl w473 x d233 x h90mm

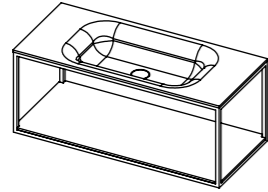

FFRB08
w1150 x d400 x h370mm
bowl w473 x d233 x h90mm

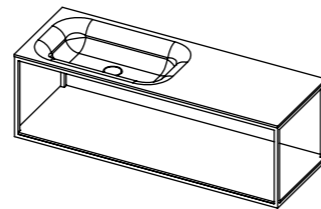

FFRB03
w1150 x d400 x h370mm
bowl w473 x d233 x h90mm

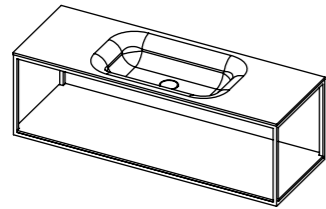

FFRB10
w900 x d400 x h370mm
bowl w473 x d233 x h90mm

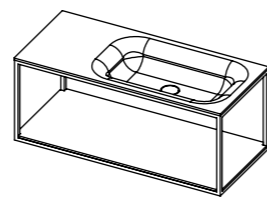

FFRB04
w1150 x d400 x h370mm
bowl w973 x d233 x h90mm

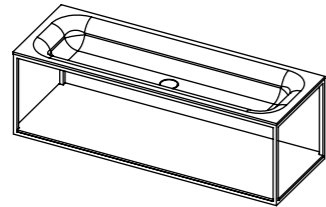

FFRB11
w1150 x d400 x h370mm
bowl w473 x d233 x h90mm

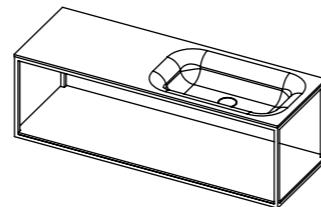

FFRB07
w900 x d400 x h370mm
bowl w473 x d233 x h90mm

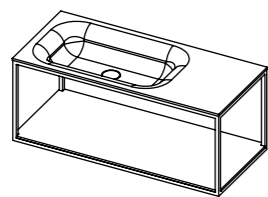

FFRB13
w1150 x d400 x h370mm
bowl w723 x d233 x h90mm

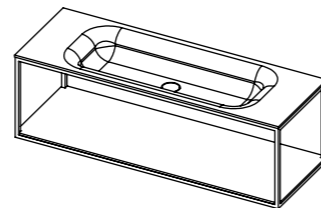



Fuse



The distinctive character of the Fuse is the amalgamation of straight and curved lines. The organic-shaped basin with the subtle but sinuous integrated overflow on the inside is punctuated by the straight lines on the outside. The back edge where Fuse is mounted on the wall is set lower to create a floating effect and shelf space at the same time. The bottle trap is almost concealed underneath the basin to make the Fuse an object.

Fuse is available in white Velluto® biobased and with a dark blue and silk grey Soft Touch coating on the outside.

Design by Marike Andeweg

- White Velluto® biobased
- Dark Blue Soft Touch coating
- Silk Grey Soft Touch coating



Fuse

Fuse Models

Specifications

- delivered with closable click-clack waste kit with Velluto® drain cover and integrated overflow
- including Fischer bolt set for wall-mounting
- including Senzo siphon (also possible to use a siphon of your own choice)
- optional: Palette finish in NCS or RAL color for projects from 10 pieces
- optional: Soft Touch coating in NCS or RAL color for projects from 10 pieces

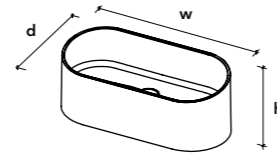

FSE02
w700 x d400 x h270mm
white

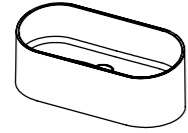

FSEST02-5008
w700 x d400 x h270mm
Dark Blue Soft Touch coating



FSEST02-7044
w700 x d400 x h270mm
Silk Grey Soft Touch coating

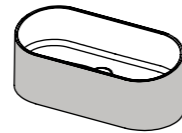

Materials and colors

Velluto®
biobased

- White
- with Dark Blue Soft Touch coating (RAL 5008)
- with Silk Grey Soft Touch coating (RAL 7044)
- with Soft Touch coating in custom NCS or RAL color possible for projects from 10 pieces
- with Palette finish in custom NCS or RAL color possible for projects from 10 pieces

Mounting

Side view

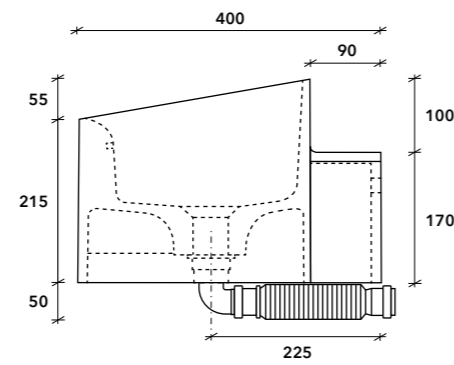

Back view

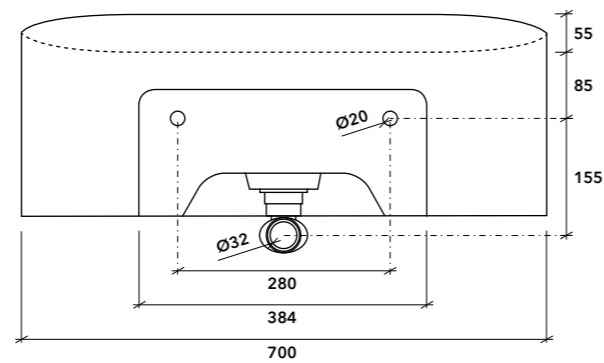



Nest



Nest is an elegant, slim-edged countertop washbasin made of white Velluto® biobased. The collection offers a round, square and rectangular model. The round model is also standard available with a silk grey Soft Touch coating.

Depending on the styling of the overall setting, Nest can create a simple and pure feeling. Yet by introducing elements like a marble shelf and copper tapware, Nest can achieve the ultimate classical and luxurious look.

Nest collection is perfectly suitable for residential as well as commercial projects. Especially with our Palette finish and haptic Soft Touch coating unique designs can be created that suit your bathroom design.

- White Velluto® biobased
- with Palette finish
- with Soft Touch coating
- Silk Grey Soft Touch coating

Nest

Specifications

- including free flow waste kit with Velluto® drain cover
- countertop model
- optional: Palette finish in custom NCS or RAL color
- optional: Soft Touch coating in custom NCS or RAL color

Ø370mm

NST370
Ø370 x h130mm
white

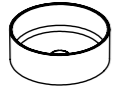

NST370-PNCS / NST370-PRAL
Ø370 x h130mm
Palette finish - custom color



NST370-SNCS / NEST370-SRAL
Ø370 x h130mm
Soft Touch coating - custom color



NST370-SSGREY
Ø370 x h130mm
Silk Grey Soft Touch coating



Nest Models

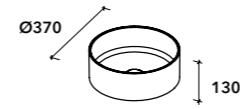

Nest

Specifications

- including free flow waste kit with Velluto® drain cover
- countertop model
- optional: Palette finish in custom NCS or RAL color
- optional: Soft Touch coating in custom NCS or RAL color

d370mm

NST3737
w370 x d370 x h130mm
white

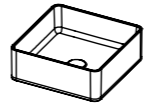

NST3737-PNCS / NST3737-PRAL
w370 x d370 x h130mm
Palette finish - custom color

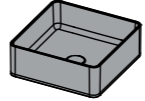

NST3737-SNCS / NST3737-SRAL
w370 x d370 x h130mm
Soft Touch coating - custom color

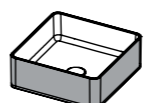

d370mm

NST3737
w370 x d370 x h130mm
white

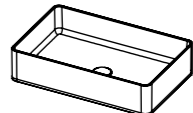

NST5837-PNCS / NST5837-PRAL
w580 x d370 x h130mm
Palette finish - custom color

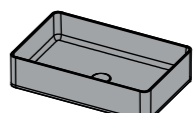

NST5837-SNCS / NST5837-SRAL
w580 x d370 x h130mm
Soft Touch coating - custom color

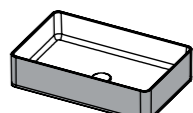

Nest Models

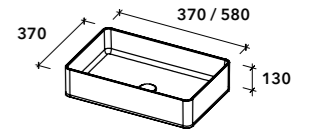

Materials and colors

- Velluto® biobased**
- White
 - with Soft Touch coating Silk Grey (RAL 7044)
 - with Palette finish in custom NCS or RAL color possible
 - with Soft Touch coating in custom NCS or RAL color possible

Drain type

Nest is delivered with matching free flow Velluto® drain cover. See drawing below.

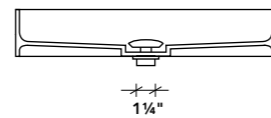

Materials and colors

- Velluto® biobased**
- White
 - with Palette finish in custom NCS or RAL color possible
 - with Soft Touch coating in custom NCS or RAL color possible

Drain type

Nest is delivered with matching free flow Velluto® drain cover. See drawing below.

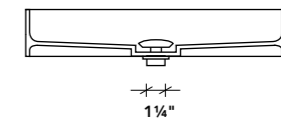

Noon countertop



Noon countertop is a friendly and bowl-shaped basin made out of Himacs that can be placed on top of our Flat shelf or a cabinet from a third party. The foot elevates the Noon from the surface, allowing for easy maintenance and adding an extra dimension to its appearance.

Design by Marike Andeweg

Noon countertop Models

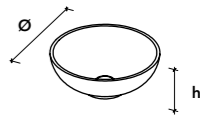

Specifications

- delivered with our Flush drain
- Noon countertop bowl should be fixed on top of a surface using flexible silicon

FNN364
Ø364 x h150mm
inside Ø340 x h114mm



FNN424
Ø424 x h160mm
inside Ø400 x h124mm



FNN484
Ø484 x h170mm
inside Ø460 x h134mm



Materials and colors

Himacs White

Drain type

Noon countertop is delivered with matching free flow Himacs drain. See drawing below.

The basin can also be equipped with our closable Pop-down drain.

Front / side view

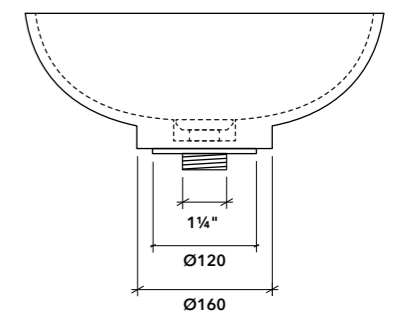



Pose



Pose collection is a serie of round and square pilars. The matte white columns have a thin edge of 10mm and are made of the high quality solid surface material Velluto® biobased.

Because of its noble appearance, Pose collection can effortlessly be used in many styles. Be it at home or in a commercial environment. To give it an individual signature, the complete product can be colored with our Palette finish. Or emphasize only the outside of Pose with our tactile Soft Touch coating.

Creating a luxurious, modest bathroom has never been this easy.

- White Velluto® biobased
- with Palette finish
- with Soft Touch coating

Pose

Specifications

- including click-clack waste kit with Velluto® drain cover
- floor-standing model
- with siphon opening in back
- optional: Palette finish in custom NCS or RAL color
- optional: Soft Touch coating in custom NCS or RAL color

Pose Models

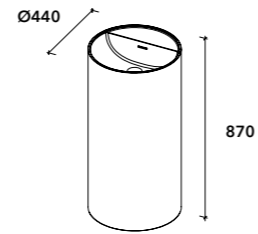

no tap hole

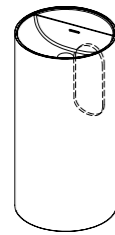

POS10
Ø440 x h870mm
white

with tap hole

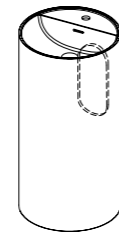

POS12
Ø440 x h870mm
white
with tap hole Ø35mm



POS10-PNCS / POS10-PRAL
Ø440 x h870mm
Palette finish - custom color

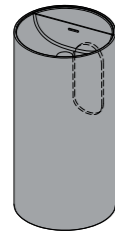

POS12-PNCS / POS12-PRAL
Ø440 x h870mm
Palette finish - custom color
with tap hole Ø35mm

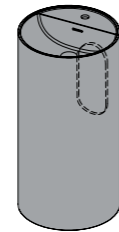

POS10-SNCS / POS10-SRAL
Ø440 x h870mm
Soft Touch coating - custom color



POS12-SNCS / POS12-SRAL
Ø440 x h870mm
Soft Touch coating - custom color
with tap hole Ø35mm

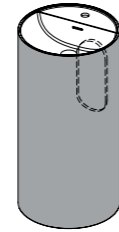

Materials and colors

Velluto®
biobased

- White
- with Palette finish in custom NCS or RAL color possible
- with Soft Touch coating in custom NCS or RAL color possible

Drain type

Pose is delivered with matching Velluto® drain cover.
See drawing below.

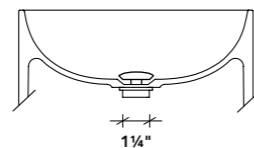

Specifications

- including click-clack waste kit with Velluto® drain cover
- floor-standing model
- with siphon opening in back
- optional: Palette finish in custom NCS or RAL color
- optional: Soft Touch coating in custom NCS or RAL color

Pose Models

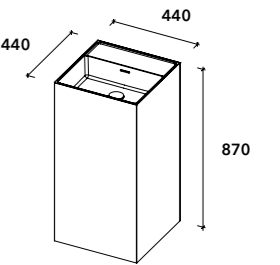

no tap hole

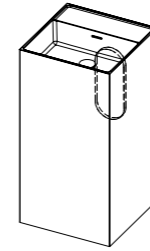

POS20
w440 x d440 x h870mm
white

with tap hole

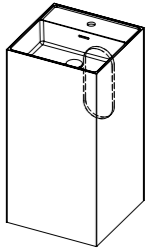

POS22
w440 x d440 x h870mm
white
with tap hole Ø35mm



POS20-PNCS / POS20-PRAL
w440 x d440 x h870mm
Palette finish - custom color

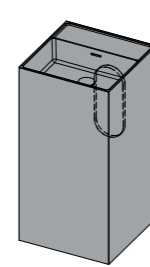

POS22-PNCS / POS22-PRAL
w440 x d440 x h870mm
Palette finish - custom color
with tap hole Ø35mm

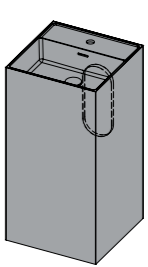

POS20-SNCS / POS20-SRAL
w440 x d440 x h870mm
Soft Touch coating - custom color

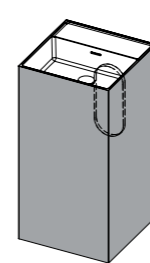

POS22-SNCS / POS22-SRAL
w440 x d440 x h870mm
Soft Touch coating - custom color
with tap hole Ø35mm

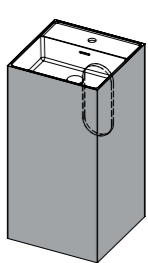

Materials and colors

Velluto®
biobased

- White
- with Palette finish in custom NCS or RAL color possible
- with Soft Touch coating in custom NCS or RAL color possible

Drain type

Pose is delivered with matching Velluto® drain cover.
See drawing below.

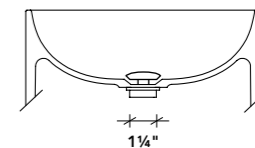



Scape



Scape collection consists of a series of black and white floor-standing Models. Carefully chosen ratios and the right mix of color and material make Scape an intriguing object. The collection takes its name from 'landscapes' in which the various inlays create different sceneries by its interaction with the Himacs monolith.

Design by Joost van der Vecht

- Black Himacs
- White Himacs
- Neolith Blanco Carrara

Scape

Specifications

- delivered in Black or White Himacs
- floor-standing with adjustable feet
- delivered with access hatch

FSC01
w840 x d840 x h900mm
with white Himacs blocks interior

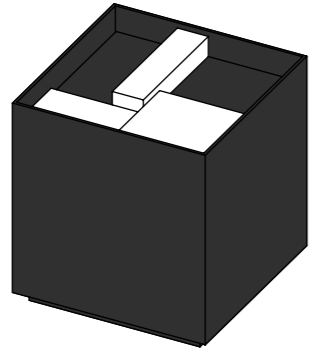

FSC03
w840 x d840 x h900mm
with Neolith Blanco Carrara interior



FSC05
w840 x d840 x h900mm
with white Himacs blocks interior

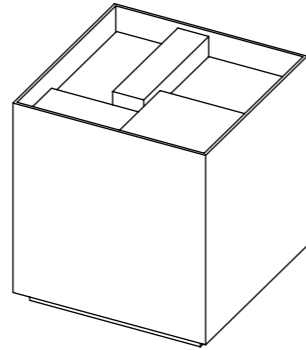

FSC07
w840 x d840 x h900mm
with Neolith Blanco Carrara interior

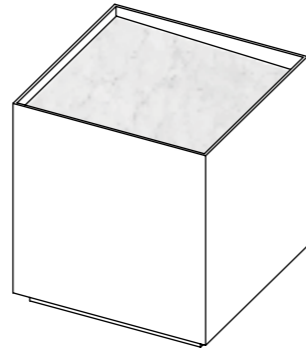

Scape Models

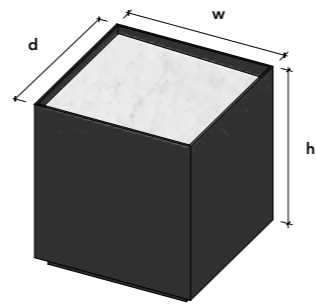

Specifications

- floor-standing with adjustable feet
- with integrated cabinet with access hatch
- to be placed against wall (back side is open)
- necessary tap hole(s) to be ordered separately by using code HH35

Scape Models

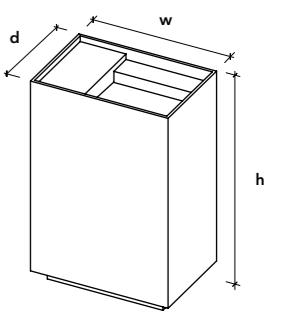

FSC20
w600 x d400 x h900mm
bowl width 376mm

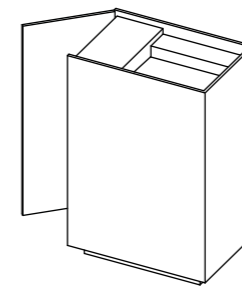

FSC30
w600 x d400 x h900mm
bowl width 376mm

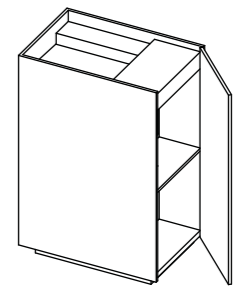

FSC21
w840 x d400 x h900mm
bowl width 616mm

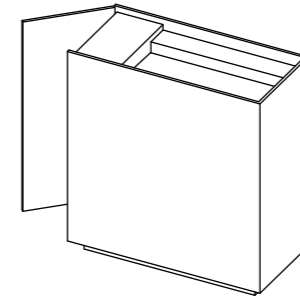

FSC31
w840 x d400 x h900mm
bowl width 616mm

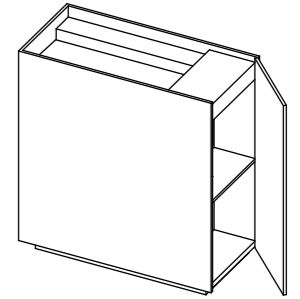

FSC22
w1000 x d400 x h900mm
bowl width 776mm

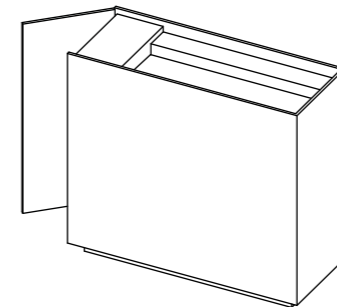

FSC32
w1000 x d400 x h900mm
bowl width 776mm

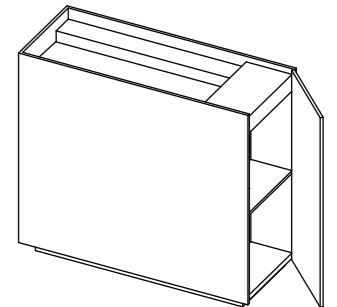

FSC23
w1200 x d400 x h900mm
bowl width 976mm

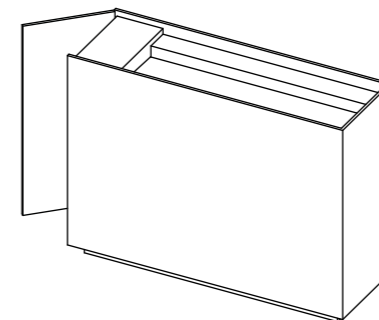

FSC33
w1200 x d400 x h900mm
bowl width 976mm

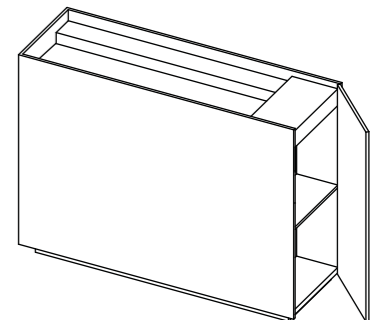

Specifications

- delivered in White Himacs
- Neolith Blanco Carrara interior
- floor-standing with adjustable feet
- with integrated cabinet with access hatch
- to be placed against wall (back side is open)

Scape Models

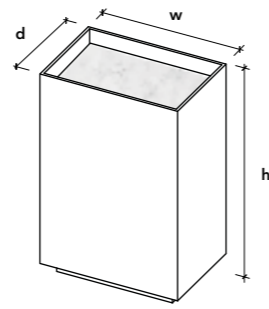

FSC40
w600 x d400 x h900mm
bowl width 576mm

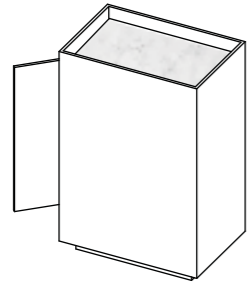

FSC50
w600 x d400 x h900mm
bowl width 576mm

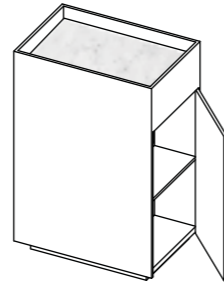

FSC41
w840 x d400 x h900mm
bowl width 816mm

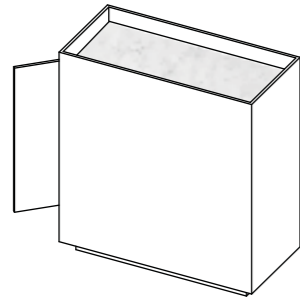

FSC51
w840 x d400 x h900mm
bowl width 816mm

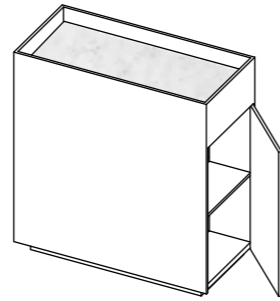

FSC42
w1000 x d400 x h900mm
bowl width 976mm

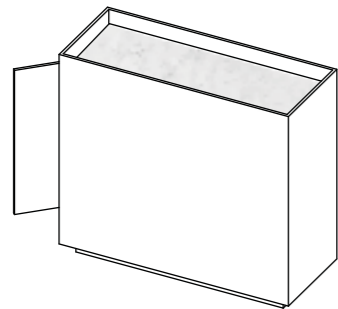

FSC52
w1000 x d400 x h900mm
bowl width 976mm

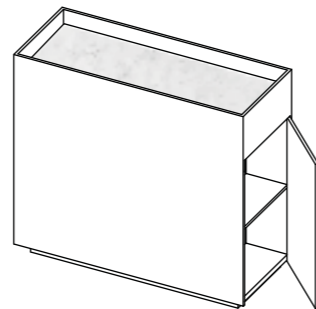

FSC43
w1200 x d400 x h900mm
bowl width 1176mm

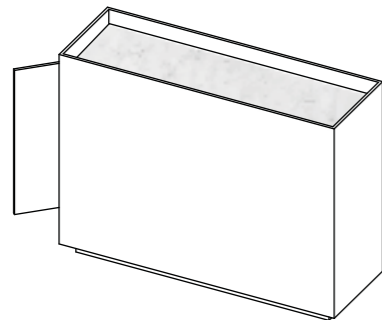

FSC53
w1200 x d400 x h900mm
bowl width 1176mm

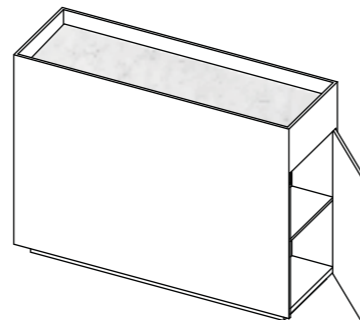

Specifications

- delivered in Black Himacs
- Neolith Blanco Carrara interior
- floor-standing with adjustable feet
- with integrated cabinet with access hatch
- to be placed against wall (back side is open)

Scape Models

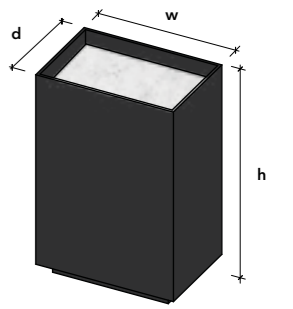

FSC60
w600 x d400 x h900mm
bowl width 576mm



FSC70
w600 x d400 x h900mm
bowl width 576mm

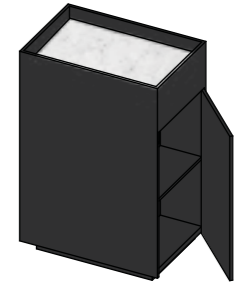

FSC61
w840 x d400 x h900mm
bowl width 816mm

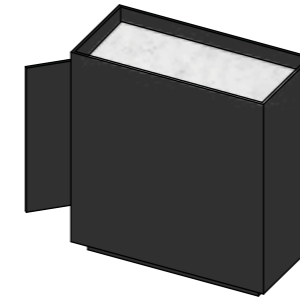

FSC71
w840 x d400 x h900mm
bowl width 816mm

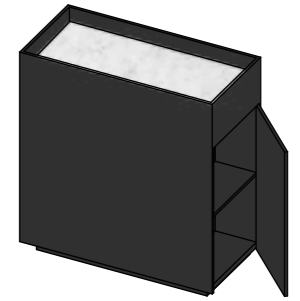

FSC62
w1000 x d400 x h900mm
bowl width 976mm

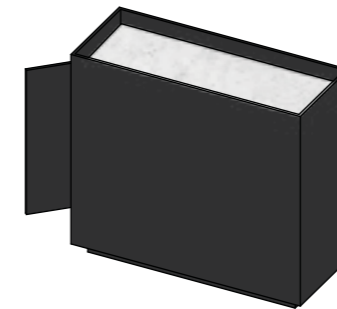

FSC72
w1000 x d400 x h900mm
bowl width 976mm

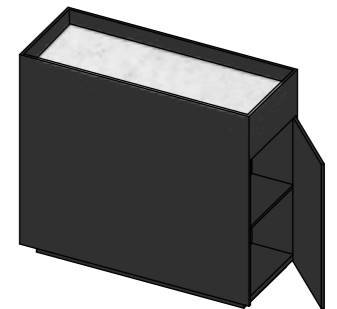

FSC63
w1200 x d400 x h900mm
bowl width 1176mm

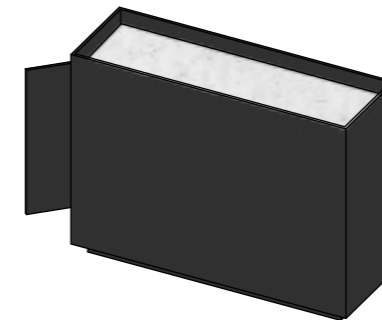

FSC73
w1200 x d400 x h900mm
bowl width 1176mm

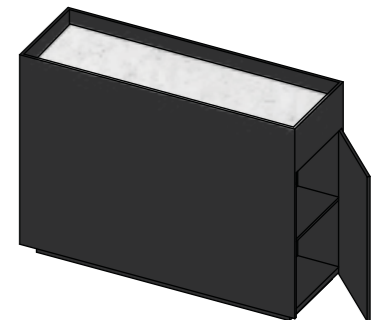



Still oval



Still collection is a serie of circular and ovoidal shapes, each with a thin edge of 5mm, that radiate a certain lightness.

Made of Velluto® biobased, the velvet touch of the material emphasizes the softness of the spacious bowls. The timeless shapes make this collection an everyday classic, for any style.

Still collection is perfectly suitable for residential as well as commercial projects. Especially with our Palette finish and haptic Soft Touch coating unique designs can be created that suit your bathroom design.

- White Velluto® biobased
- with Palette finish
- with Soft Touch coating
- with Soft Touch coating 'Clairz color'

Still oval

Still Models

Specifications

- including free flow waste kit with Velluto® drain cover
- countertop model
- optional: Palette finish in custom NCS or RAL color
- optional: Soft Touch coating in custom NCS or RAL color

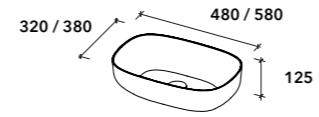

d320mm

STL4832
w480 x d320 x h125mm
white



STL4832-PWCLAY
w480 x d320 x h125mm
Palette finish in Warm Clay

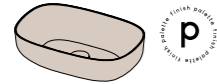

STL4832-PNCS / STL4832-PRAL
w480 x d320 x h125mm
Palette finish in custom color



STL4832-SNCS / STL4832-SRAL
w480 x d320 x h125mm
Soft Touch finish in custom color



d380mm

STL4832
w480 x d320 x h125mm
white



STL5838-PWCLAY
w580 x d380 x h125mm
Palette finish in Warm Clay

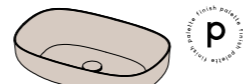

STL5838-PNCS / STL5838-PRAL
w580 x d380 x h125mm
Palette finish in custom color



STL5838-SNCS / STL5838-SRAL
w580 x d380 x h125mm
Soft Touch coating in custom color



STL5838-SCZ
w580 x d380 x h125mm
Soft Touch coating in 'CLAIRZ' color

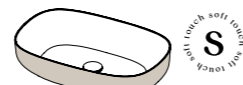

Materials and colors

Velluto®
biobased

- White
- with Palette finish in custom NCS or RAL color possible
- with Soft Touch coating in custom NCS or RAL color possible

Drain type

Still is delivered with matching free flow Velluto® drain cover. See drawing below.

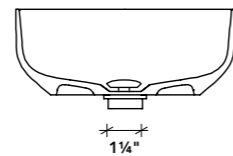



Still round



Still collection is a serie of circular and ovoidal shapes, each with a thin edge of 5mm, that radiate a certain lightness.

Made of Velluto® biobased, the velvet touch of the material emphasizes the softness of the spacious bowls. The timeless shapes make this collection an everyday classic, for any style.

Still collection is perfectly suitable for residential as well as commercial projects. Especially with our Palette finish and haptic Soft Touch coating unique designs can be created that suit your bathroom design.

- White Velluto® biobased
- with Palette finish
- with Soft Touch coating

Still round

Still Models

Specifications

- including free flow waste kit with Velluto® drain cover
- countertop model
- optional: Palette finish in custom NCS or RAL color
- optional: Soft Touch coating in custom NCS or RAL color

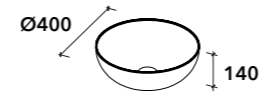

	— Ø400mm	
STL400 Ø400 x h140mm white		
STL400-PWCLAY Ø400 x h140mm Palette finish in Warm Clay		
STL400-PDBLACK Ø400 x h140mm Palette finish in Deep Black		
STL400-PNCS / STL400-PRAL Ø400 x h140mm Palette finish in custom color		
STL400-SNCS / STL400-SRAL Ø400 x h140mm Soft Touch finish in custom color		

Materials and colors

Velluto®
biobased

- White
- with Palette finish in custom NCS or RAL color possible
- with Soft Touch coating in custom NCS or RAL color possible

Drain type

Still is delivered with matching free flow Velluto® drain cover. See drawing below.

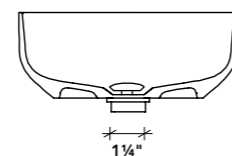

Specifications

- deck mounted single lever mixer tap
- including 3/8" GAS warm and cold water fitting
- satin stainless steel

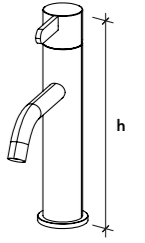

LF10122-SA
h220mm



Materials and colors

Satin stainless steel

A modest design, that matches with all our basins.

At Not Only White we aim to keep it simple. But always distinctive. This is how our Leaf tap series was born.

What makes this design appealing is the 5cm long lever with rounded grip for easy use. The shape of the lever is inspired on the leaves of the Pagoda tree.

Design by Marike Andeweg



Leaf



A modest design, that matches with all our basins. At Not Only White we aim to keep it simple. But always distinctive. This is how our Leaf tap series was born.

What makes this design appealing is the 5cm long lever with rounded grip for easy use. The deck mounted mixer is flexible when it comes to its position on the surface.

The shape of the lever is inspired on the leaves of the Pagoda tree.

design by Marike Andeweg

● Stainless steel

Leaf

Leaf Models

Specifications

- deck mounted spout with 1/2" fitting
- deck mounted single lever basin mixer with 3/8"GAS warm and cold water fitting
- available as separate items or in sets
- satin stainless steel

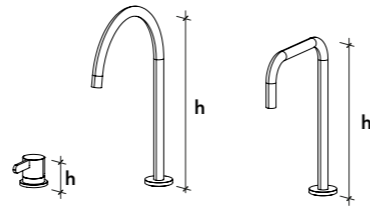

LFSET01-SA
h350mm
rounded spout + mixer

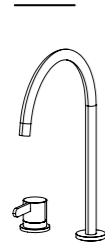

LF241-SA
h350mm
rounded spout

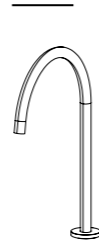

LFSET02-SA
h300mm
edged spout + mixer

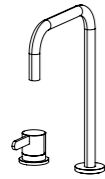

LF235-SA
h300mm
edged spout

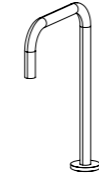

LF711-SA
h57xØ40mm
single lever basin mixer



Materials and colors

Satin stainless steel





The Axis bath is a free-standing, rectangular bath with rounded internal lines. The sloping side, combined with its generous proportions, makes the Axis a wonderfully comfortable bath tub. The overflow is subtly integrated within the tub and the drain plug is made of the same material as the bath.

Axis bath is made of Velluto® biobased, which can be perfectly combined with the white Himacs of our Not Only White custom made basins.

Specifications

- including pop-up waste kit with Velluto® cover and 1 ½" bottle trap
- with integrated overflow
- not fit for third party fill or overflow systems
- optional: Palette finish in NCS or RAL color
- optional: Soft Touch coating in NCS or RAL color

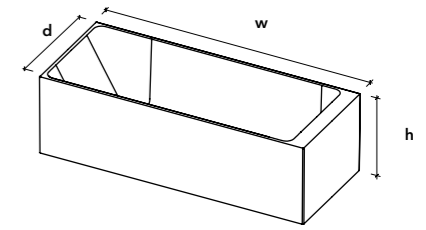

FAX01
w1680 x d680 x h500mm
 white
 capacity at overflow level 310 liters
 net weight ±174kg

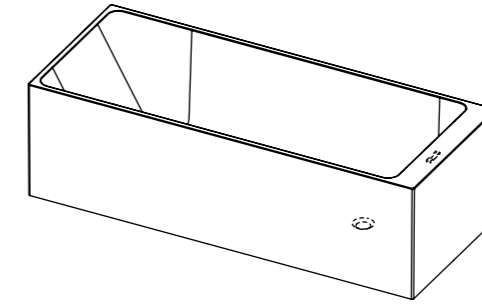

FAX01-PNCS / FAX01-PRAL
w1680 x d680 x h500mm
 Palette finish - custom color
 capacity at overflow level 310 liters
 net weight ±174kg

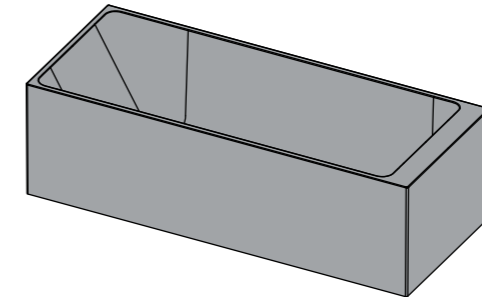

FAX01-SNCS / FAX01-SRAL
w1680 x d680 x h500mm
 Soft Touch coating - custom color
 capacity at overflow level 310 liters
 net weight ±174kg

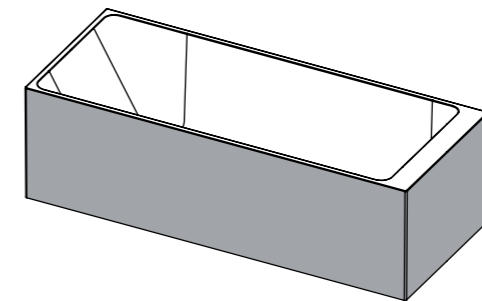

Materials and colors

Velluto® biobased

- White
- with Palette finish in NCS or RAL color
- with Soft Touch coating in NCS or RAL color



Ease bath is best described as a warmly, playful asymmetrical design but with an almost sculptural appearance. Because of its compact dimensions this bath fits easily in smaller bathrooms while keeping its spacious, luxurious look.

With its comfortable inner lines, Ease bath creates a wonderful bathing experience. And when not in use, a beautiful object to look at.

Specifications

- including pop-up waste kit with Velluto® drain cover and 1 ½" bottle trap
- with integrated overflow
- not fit for third party fill or overflow systems
- capacity at overflow level 266 liters
- net weight ±x100kg
- optional: Palette finish in custom NCS or RAL color possible
- optional: Soft Touch coating in custom NCS or RAL color possible

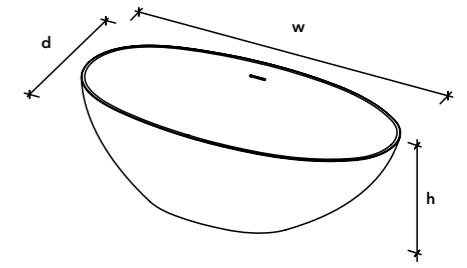

FEA02
w1600 x d750x x h550mm
white

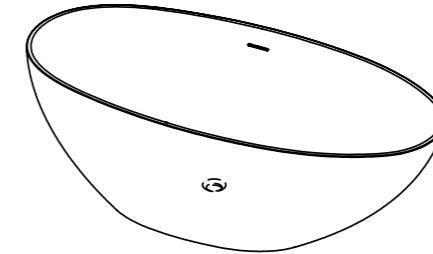

FEA02-PNCS / FEA02-PRAL
w1600 x d750x x h550mm
Palette finish - custom color

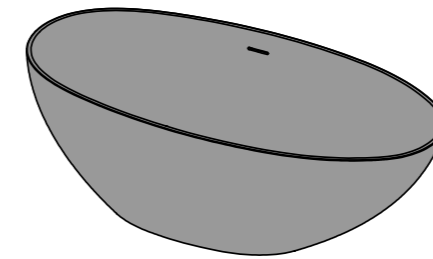

FEA02-SNCS / FEA02-SRAL
w1600 x d750x x h550mm
Soft Touch coating - custom color

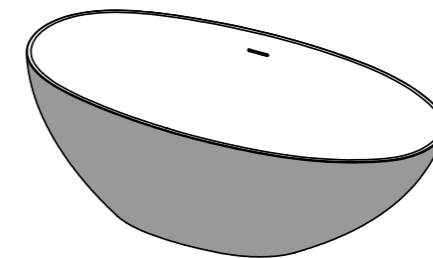

Materials and colors

Velluto® biobased

- White
- with Palette finish in custom NCS or RAL color
- with Soft Touch coating in custom NCS or RAL color



Fine



Because of its thin lines and gentle curved design, our Fine baths appears light and soft. As precious earthenware. Just by looking at Fine, you can instantly feel a summer breeze entering your bathroom. Fine bath is available in 3 sizes, to make sure there is always the right dimensions to create harmony between bath and space.

Fine is made in white Velluto® biobased. Play with color and add another layer of luxury into your bathroom by using our unique Palette finish. Palette is easy to clean and UV resistant. Because of the availability in custom NCS and RAL colors, you can create a distinctive aesthetic appearance with our Fine bath. At home or in a hotel.

- White Velluto® biobased
- with Palette finish
- with Soft Touch coating

Fine

Fine Models

Specifications

- including pop-up waste kit with Velluto® drain cover and 1 ½" bottle trap
- with integrated overflow
- not fit for third party fill or overflow systems
- capacity at overflow level 238 liters
- net weight ±82kg
- optional: Palette finish in NCS or RAL color possible
- optional: Soft Touch coating in NCS or RAL color possible

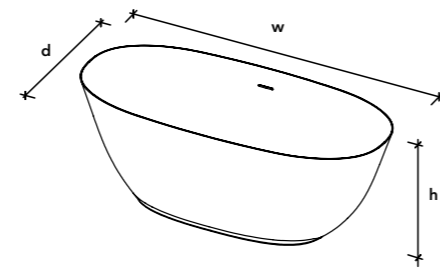

FFI02
w1600 x d700 x h580mm
white

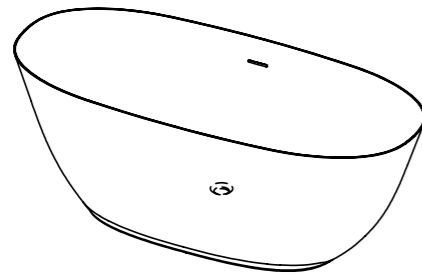

FFI02-PNCS / FFI02-PRAL
w1600 x d700 x h580mm
Palette finish - custom color

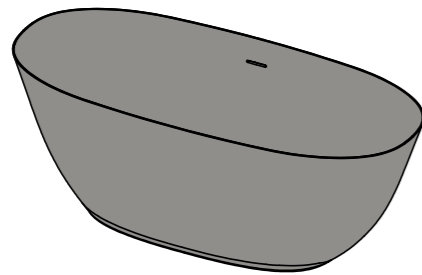

FFI02-SNCS / FFI02-SRAL
w1600 x d700 x h580mm
Soft Touch coating - custom color

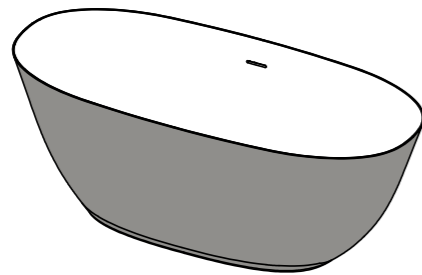

Materials and colors

Velluto® biobased

- White
- with Palette finish in custom NCS or RAL color
- with Soft Touch coating in custom NCS or RAL color

Fine Models

Specifications

- including pop-up waste kit with Velluto® drain cover and 1 ½" bottle trap
- with integrated overflow
- not fit for third party fill or overflow systems
- capacity at overflow level 271 liters
- net weight ±127kg
- optional: Palette finish in NCS or RAL color possible
- optional: Soft Touch coating in NCS or RAL color possible

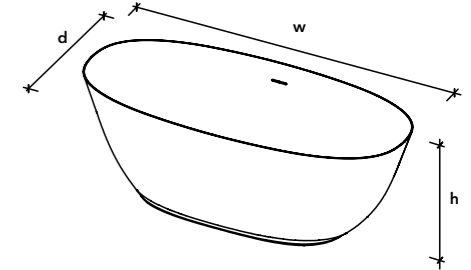

FFI03
w1700 x d750 x h580mm
white

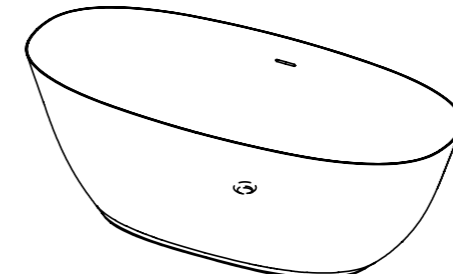

FFI03-PNCS / FFI03-PRAL
w1700 x d750 x h580mm
Palette finish - custom color

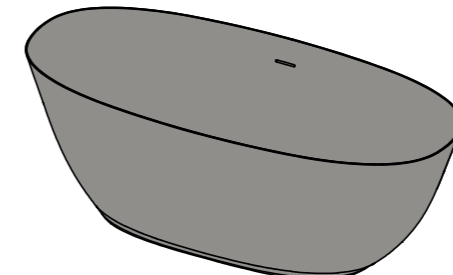

FFI03-SNCS / FFI03-SRAL
w1700 x d750 x h580mm
Soft Touch coating - custom color

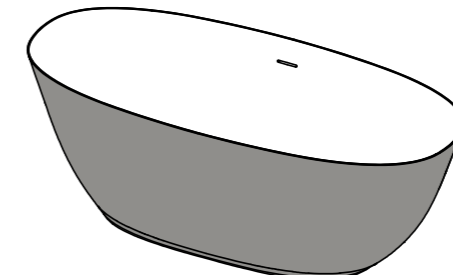

Materials and colors

Velluto® biobased

- White
- with Palette finish in custom NCS or RAL color
- with Soft Touch coating in custom NCS or RAL color

Specifications

- including pop-up waste kit with Velluto® drain cover and 1 ½" bottle trap
- with integrated overflow
- not fit for third party fill or overflow systems
- capacity at overflow level 316 liters
- net weight ±142kg
- optional: Palette finish in NCS or RAL color possible
- optional: Soft Touch coating in NCS or RAL color possible

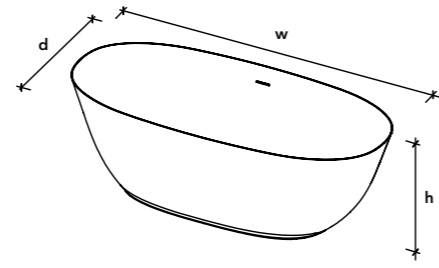

FF104
w1800 x d800 x h580mm
white

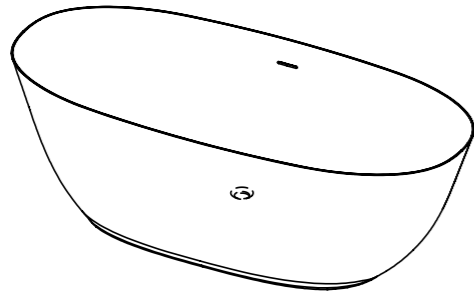

FF104-PNCS / FF104-PRAL
w1800 x d800 x h580mm
Palette finish - custom color

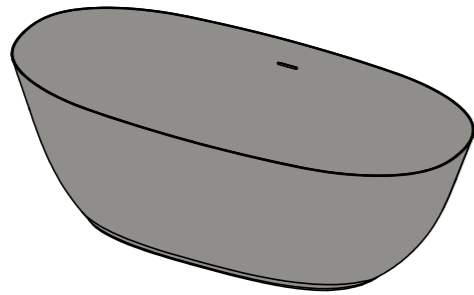

FF104-SNCS / FF104-SRAL
w1800 x d800 x h580mm
Soft Touch coating - custom color

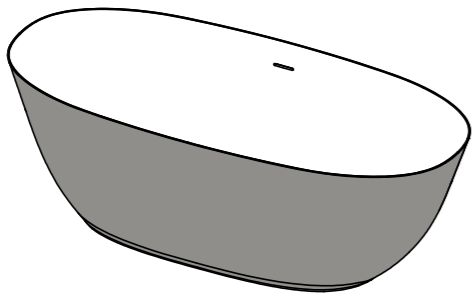

Materials and colors

Velluto® biobased

- White
- with Palette finish in custom NCS or RAL color
- with Soft Touch coating in custom NCS or RAL color





Loop



Loop FLP01
Private residence
Interior design by Studio Niels
Photography by Serge Technau

This free-standing egg-shaped bath is all about an elegant play of lines. The overflow is subtly integrated within the tub and the drain plug is in the same material as the bath.

Loop bath is made of Velluto® biobased. Especially designed for the Loop bath, the Loop bath tray hugs the curves of the tub. With one's favourite magazine, candle and drink within easy reach, bathing is more relaxing than ever.

- White Velluto® biobased
- with Palette finish
- with Soft Touch coating

Loop

Specifications

- including pop-up waste kit with white Velluto® drain cover and 1 ½" bottle trap
- with integrated overflow
- not fit for third party fill or overflow systems
- capacity at overflow level 310 liters
- net weight ±102kg
- optional: Palette finish in NCS or RAL color possible
- optional: Soft Touch coating in NCS or RAL color possible

Loop Models

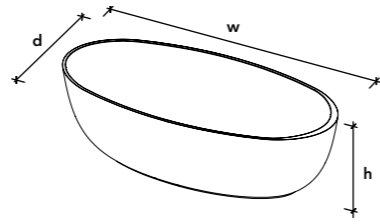

FLP01
w1690 x d800 x h500mm
white

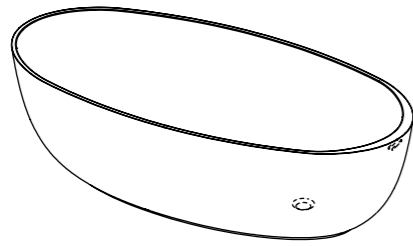

FLP01-PNCS / FLP01-PRAL
w1690 x d800 x h500mm
Palette finish - custom color

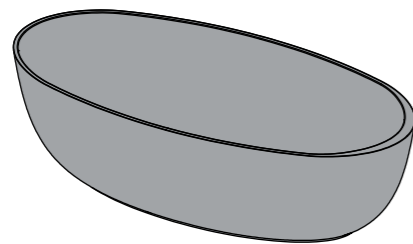

FLP01-SNCS / FLP01-SRAL
w1690 x d800 x h500mm
Soft Touch coating - custom color

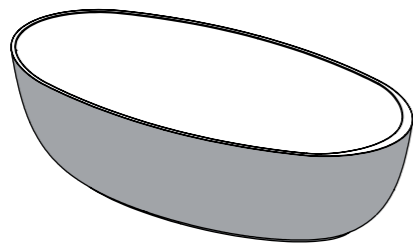

Materials and colors

Velluto® biobased

- White
- with Palette finish in custom NCS or RAL color
- with Soft Touch coating in custom NCS or RAL color

Loop Models

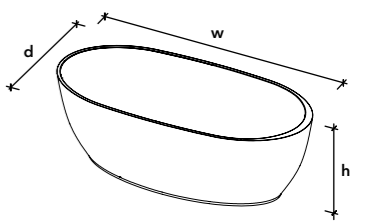

Specifications

- including pop-up waste kit with white Velluto® drain cover and 1 ½" bottle trap
- with integrated overflow
- not fit for third party fill or overflow systems
- capacity at overflow level 247 liters
- net weight ±90kg
- optional: Palette finish in NCS or RAL color possible
- optional: Soft Touch coating in NCS or RAL color possible

FLP03
w1500 x d700 x h500mm
white

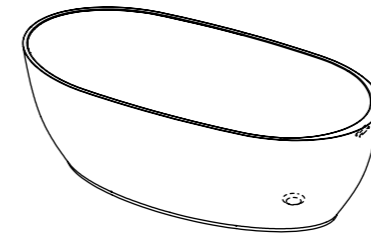

FLP03-PNCS / FLP03-PRAL
w1500 x d700 x h500mm
Palette finish - custom color

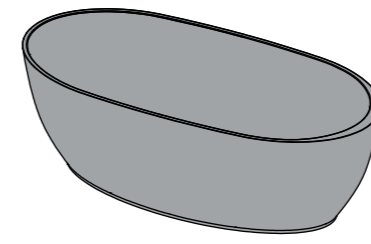

FLP03-SNCS / FLP03-SRAL
w1500 x d700 x h500mm
Soft Touch coating - custom color

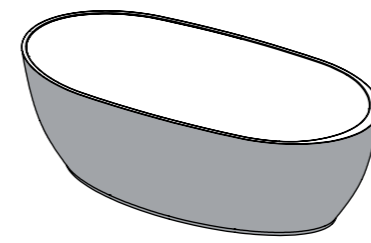

Materials and colors

Velluto® biobased

- White
- with Palette finish in custom NCS or RAL color
- with Soft Touch coating in custom NCS or RAL color

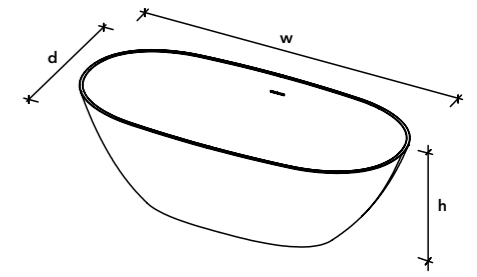

Specifications

- including pop-up waste kit with white Velluto® cover and 1 ½" bottle trap
- with integrated overflow
- not fit for third party fill or overflow systems
- capacity at overflow level 318 liters
- net weight ±101kg
- optional: Palette finish in custom NCS or RAL color possible
- optional: Soft Touch coating in custom NCS or RAL color possible

FMU04
w1770 x d800 x h565mm
white

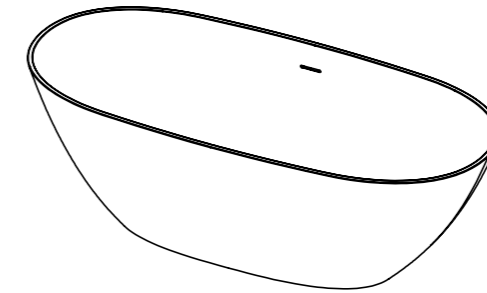

FMU04-PNCS / FMU04-PRAL
w1770 x d800 x h565mm
Palette finish - custom color

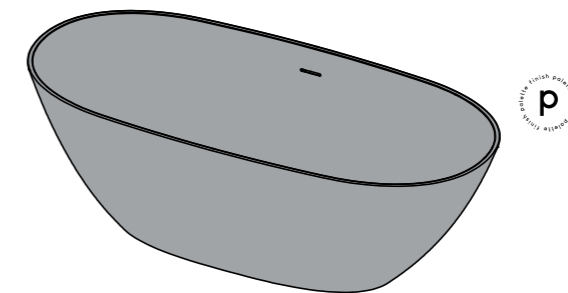

FMU04-SNCS / FMU04-SRAL
w1770 x d800 x h565mm
Soft Touch coating - custom color

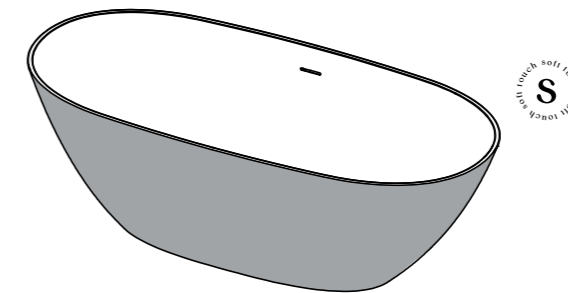

Materials and colors

Velluto® biobased

- White
- with Palette finish in custom NCS or RAL color
- with Soft Touch coating in custom NCS or RAL color

Muse bath is an ode to bathing. Noble and modest at the same time. Simple, straight outlines and generous on the inside. Balanced proportions and with a very comfortable support at both sides.

Muse is made in white Velluto®. Play with color and add another layer of luxury into your bathroom by using our unique Palette finish. Palette is easy to clean and UV resistant. Because of the availability in many colors, you can create a distinctive aesthetic appearance with our Muse bath. At home or in a hotel.



Specifications

- available in white, grey or concrete Himacs

Axis bath tray

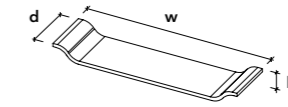

AAATR01
w685 x d175 x h52mm
bath tray for Axis FAX01

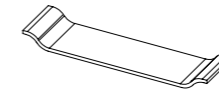

AAATR02
w740 x d175 x h52mm
bath tray for Axis FAX02

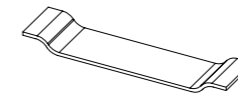

Loop bath tray

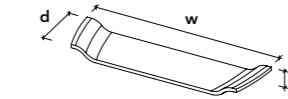

ALPTR01
w700 x d175 x h44mm
bath tray for Loop FLP01

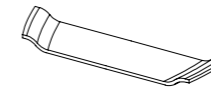

ALPTR03
w670 x d175 x h44mm
bath tray for Loop FLP03

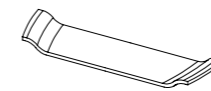

Materials and colors

- Himacs**
- White
 - Grey
 - Concrete

Base handrinse



As the name suggests, the Base handrinse is a collection of basic-shaped models. It is characterized by the 12mm radius inside the basin.

This collection aims to be accessible, adaptable and easy to maintain. Not only is Base perfect for the domestic environment, but its characteristics also make Base an ideal choice in hygienic surroundings and intensively-used restrooms.

Design by Marike Andeweg

Base handrinse Models

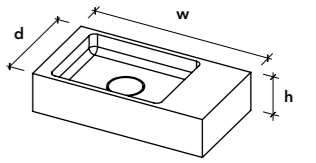

Specifications

- delivered with our Flush drain
- delivered as wall-mounted version including mounting holes in the back edge
- standard size tap hole Ø30mm; for UK Ø35mm
- Base handrinse Models are also available in top-mounted versions

d200mm - no tap hole

HBS01
w300 x d200 x h85mm
bowl w240 x d176 x h40mm

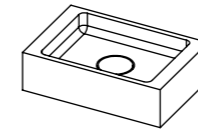

HBS02
w300 x d200 x h130mm
bowl w240 x d176 x h60mm

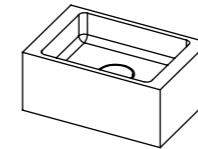

HBS03
w370 x d200 x h85mm
bowl w240 x d176 x h40mm

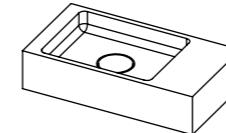

HBS04
w370 x d200 x h130mm
bowl w240 x d176 x h60mm

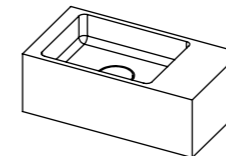

HBS05
w370 x d200 x h85mm
bowl w240 x d176 x h40mm

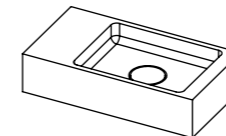

HBS06
w370 x d200 x h130mm
bowl w240 x d176 x h60mm

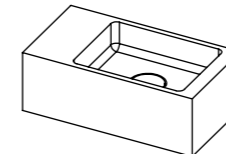

d200mm - with tap hole

HBS07
w370 x d200 x h85mm
bowl w240 x d176 x h40mm

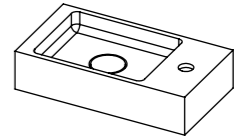

HBS08
w370 x d200 x h130mm
bowl w240 x d176 x h60mm

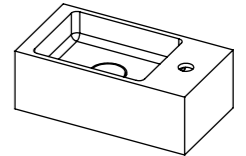

HBS09
w370 x d200 x h85mm
bowl w240 x d176 x h40mm

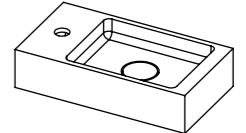

HBS10
w370 x d200 x h130mm
bowl w240 x d176 x h60mm

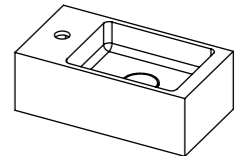

Materials and colors

Himacs White

Base Light handrinse



Base Light handrinse is the slim sibling of the Base handrinse collection. With an overall depth of 14 centimeters and a wall thickness and inside radius of only 9 millimeters, Base Light is the compact solution for small spaces.

This collection aims to be accessible, adaptable and easy to maintain. Base Light is perfect for the domestic environment.

Design by Marike Andeweg

Base Light handrinse Models

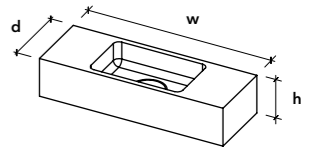

Specifications

- delivered with our Flush drain
- delivered as wall-mounted version including mounting holes in the back edge
- standard size tap hole Ø30mm; for UK Ø35mm
- Base Light handrinse Models are also available in top-mounted versions

d140mm - no tap hole

HBS11
w400 x d140 x h85mm
bowl w200 x d122 x h50mm

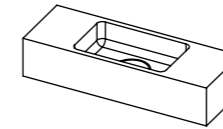

d140mm - with tap hole

HBS16
w400 x d140 x h85mm
bowl w200 x d122 x h50mm

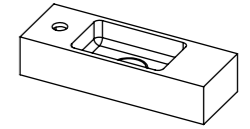

HBS17
w400 x d140 x h85mm
bowl w200 x d122 x h50mm

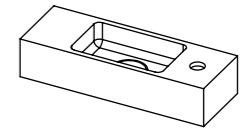

HBS12
w500 x d140 x h85mm
bowl w200 x d122 x h50mm

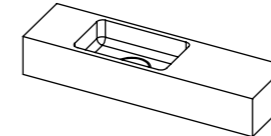

HBS18
w500 x d140 x h85mm
bowl w200 x d122 x h50mm

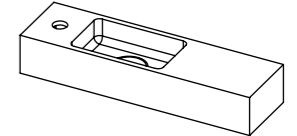

HBS13
w600 x d140 x h85mm
bowl w200 x d122 x h50mm

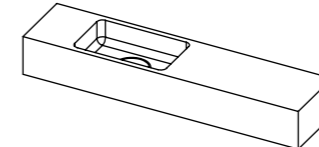

HBS19
w600 x d140 x h85mm
bowl w200 x d122 x h50mm

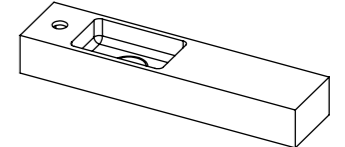

HBS14
w500 x d140 x h85mm
bowl w200 x d122 x h50mm

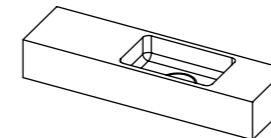

HBS20
w500 x d140 x h85mm
bowl w200 x d122 x h50mm

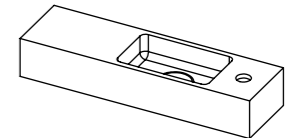

HBS15
w600 x d140 x h85mm
bowl w200 x d122 x h50mm

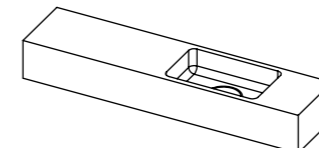

HBS21
w600 x d140 x h85mm
bowl w200 x d122 x h50mm

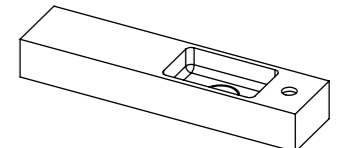

Materials and colors

Himacs White

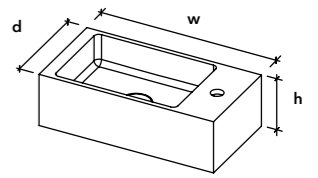

Specifications

- delivered with our Flush drain
- delivered as wall-mounted version including mounting holes in the back edge
- standard size tap hole Ø30mm; for UK Ø35mm
- Base Bold handrinse Models are also available in top-mounted versions

d224m - no tap hole

d224mm - with tap hole

HBS31
w360 x d224 x h130mm
bowl w300 x d200 x h75mm

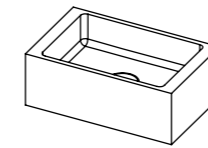

HBS37
w430 x d224 x h130mm
bowl w300 x d200 x h75mm

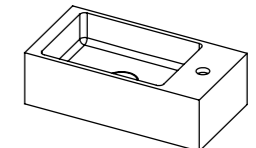

HBS32
w360 x d224 x h145mm
bowl w300 x d200 x h100mm

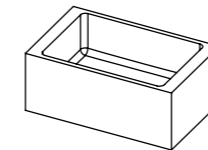

HBS38
w430 x d224 x h145mm
bowl w300 x d200 x h100mm

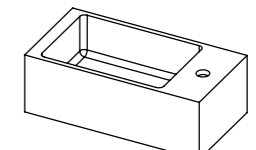

HBS33
w430 x d224 x h130mm
bowl w300 x d200 x h75mm

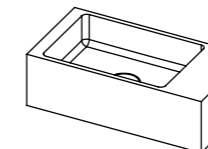

HBS39
w430 x d224 x h130mm
bowl w300 x d200 x h75mm

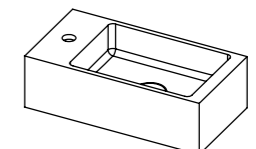

HBS34
w430 x d224 x h145mm
bowl w300 x d200 x h100mm

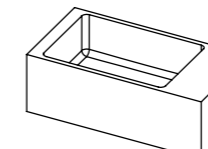

HBS40
w430 x d224 x h145mm
bowl w300 x d200 x h100mm

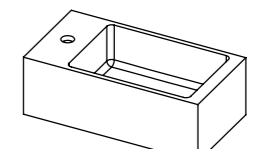

HBS35
w430 x d224 x h130mm
bowl w300 x d200 x h75mm

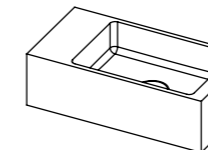

HBS36
w430 x d224 x h145mm
bowl w300 x d200 x h100mm

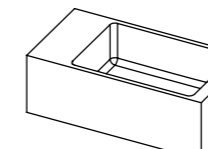

Base Bold handrinse is the big brother of the Base handrinse collection. The bigger bowl gives you a bit more space to freshen up.

The Base Bold handrinse is like the other models in this collection: accessible, adaptable and easy to maintain. A welcome solution for your sanitary space.

Design by Marike Andeweg

Materials and colors

Himacs White

Handrinse layout

Make a choice between Base, Base Light or Base Bold handrinse and fill in positions 1 and 2. After this define the size of the bowl. Go to page 101 for the bowl sizes.

BASE

- ① max. 2000mm
- ② min. 30mm
min. 80mm with tap hole

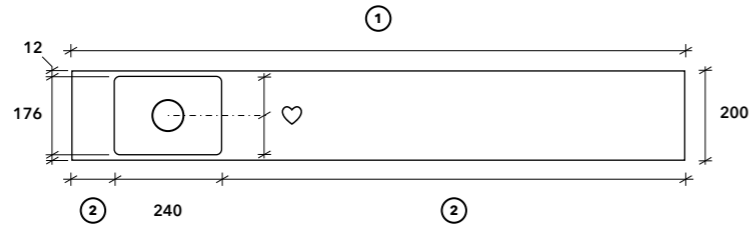

BASE LIGHT

- ① max. 2000mm
- ② min. 30mm
min. 80mm with tap hole

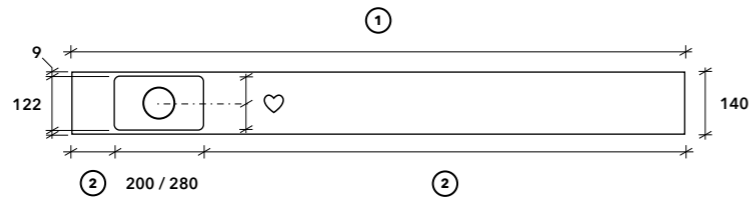

BASE BOLD

- ① max. 2000mm
- ② min. 30mm
min. 80mm with tap hole

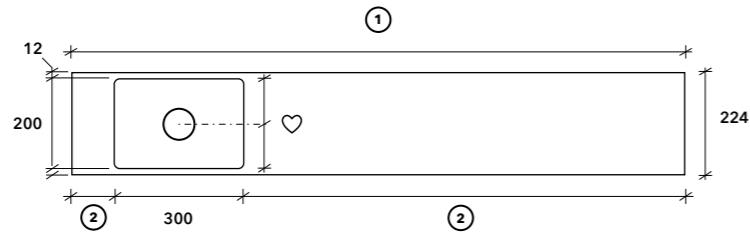

Edge

Base, Base Light and Base Bold handrinse always come with a front and back edge. In order to conceal the bowl, Not Only White recommends an edge height as mentioned on the next page at the 'Bowls' section.

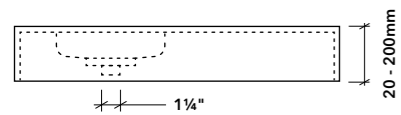

EH100
Edge 20 - 100mm high

EH150
Edge 101 - 150mm high

EH200
Edge 151 - 200mm high

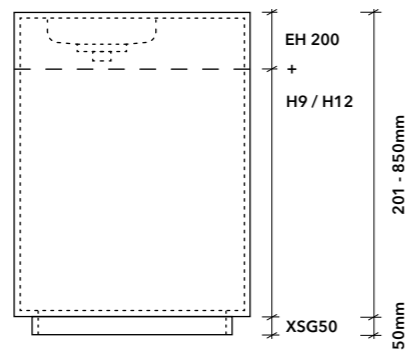

EH200 + remaining m² in H9 for Base Light
Edge 201 - 850mm high

EH200 + remaining m² in H12 for Base and Base Bold
Edge 201 - 850mm high

XSG50
50mm plinth for floor-standing model

Bowls

Base handrinse bowl for basin d200mm

CHBS24174
w240x d176 x h40mm
rec. edge height 85mm



CHBS24176
w240x d176 x h60mm
rec. edge height 105mm



CHBS241710
w240x d176 x h100mm
rec. edge height 145mm



Base Light handrinse bowl for basin d140mm

CHBSL20125
w200 x d122 x h50mm
rec. edge height 95mm



CHBSL20128
w200 x d122 x h85mm
rec. edge height 130mm



CHBSL28128
w280 x d122 x h85mm
rec. edge height 130mm



Base Bold handrinse bowl for basin d224mm

CHBS30205
w300 x d200 x h50mm
rec. edge height 90mm

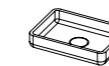

CHBS30207
w300 x d200 x h75mm
rec. edge height 115mm

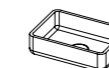

CHBS302010
w300 x d200 x h100mm
rec. edge height 140mm

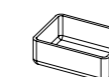

Drain type

Depending on how the handrinse basin needs to look and work, you can choose from different drain types for Base handrinse.

- ① **FLUSH DRAIN**
free flow drain 

Base handrinse bowls are standard equipped with our Flush drain. This drain allows water to flow through at all times and cannot be closed.

Flush drain is free of charge

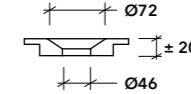
- ② **DR72 DRAIN HOLE**
for a third party drain 

The DR72 drain hole is used for third party drains.

Not Only White recommends to use a free flow drain.

DR72 drain is free of charge

Overflow

An overflow is not possible.

Tap hole

If you need to fit a top-mounted tap, we can pre-drill the hole (code **HH35**).

Consider the space you would need to secure the tap with a tightening ring.

Top-mounted tap without overflow:

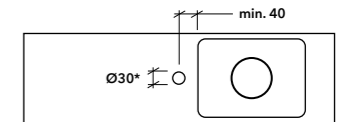

* Tap hole for UK 35mm

Mounting holes

To install a handrinse basin to the wall, Not Only White can provide mounting holes (code **OVHL**) in the back edge.

Handrinse basins up to 600mm need two holes. Any handrinse basin wider than 600mm, we advise to have an extra hole up to 1.2m and two extra holes up to 2m.

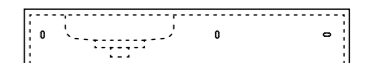

Please refer to **Ribs** for handrinse basins that need to be mounted on a cabinet. In this case mounting holes won't be needed.

Ribs

Please refer to page 11.

Cut-outs and edge finishes

Please refer to page 10.

Materials and colors

Himacs White



Blend handrinse

The Blend handrinse is the smaller version of the Blend basin. The top of the organic-shaped basin fluidly forms the 6 centimeters high backsplash giving the Blend handrinse a nostalgic look.

The Blend handrinse is also available with an edge and both models are equipped with the Flush drain made out of Himacs, just like the basin itself.

Design by Marike Andeweg



Blend handrinse Models

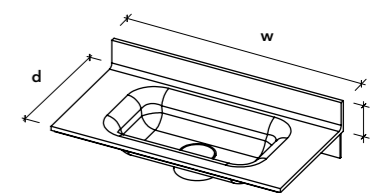

Specifications

- delivered with our Flush drain
- delivered as wall-mounted version including white powder coated bracket
- standard size tap hole Ø30mm; for UK Ø35mm

d260mm - no tap hole

HBL02
w500 x d260 x h69mm
bowl w290 x d144 x h60mm

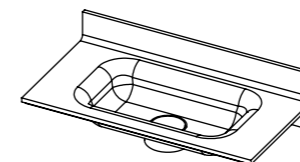

HBL03
w600 x d260 x h69mm
bowl w290 x d144 x h60mm

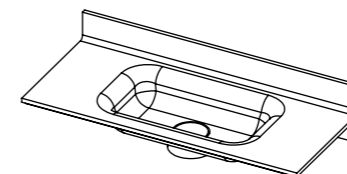

HBL04
w500 x d260 x h69mm
bowl w290 x d144 x h60mm

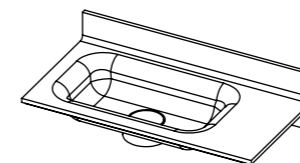

HBL05
w600 x d260 x h69mm
bowl w290 x d144 x h60mm

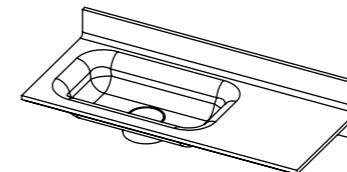

HBL06
w500 x d260 x h69mm
bowl w290 x d144 x h60mm

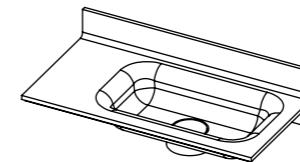

HBL07
w600 x d260 x h69mm
bowl w290 x d144 x h60mm

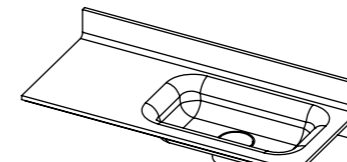

d260mm - with tap hole

HBL08
w500 x d260 x h69mm
bowl w290 x d144 x h60mm

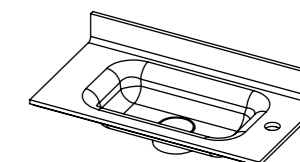

HBL09
w500 x d260 x h69mm
bowl w290 x d144 x h60mm

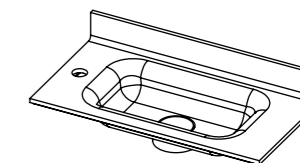

HBL10
w600 x d260 x h69mm
bowl w290 x d144 x h60mm

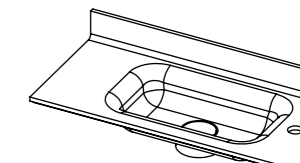

HBL11
w600 x d260 x h69mm
bowl w290 x d144 x h60mm

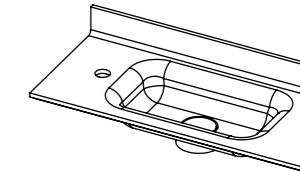

HBL12
w500 x d260 x h69mm
bowl w290 x d144 x h60mm

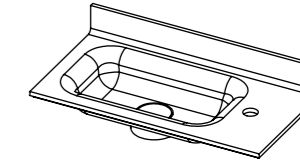

HBL13
w600 x d260 x h69mm
bowl w290 x d144 x h60mm

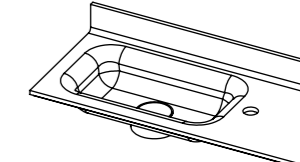

HBL14
w500 x d260 x h69mm
bowl w290 x d144 x h60mm

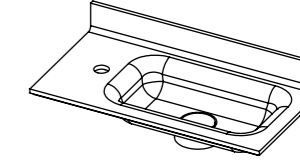

HBL15
w600 x d260 x h69mm
bowl w290 x d144 x h60mm

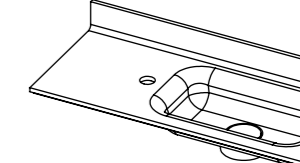



What makes the Blend collection so special is the fusion of the organic-shaped bowl with the linear top. The invisible design of the Flush drain fits the Blend perfectly. Blend invites you to touch it.

The curved design of the bowl allows for easy maintenance.

Design by Marike Andeweg

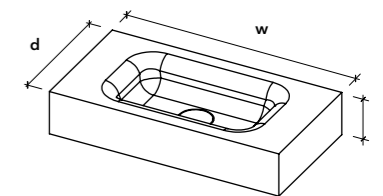

Specifications

- delivered with our Flush drain
- delivered as wall-mounted version including mounting holes in the back edge
- standard size tap hole Ø30mm; for UK Ø35mm
- Blend handrinse Models HBL16 -30 are also available in top-mounted versions

d260mm - no tap hole

HBL16
w405 x d260 x h95mm
bowl w290 x d144 x h60mm

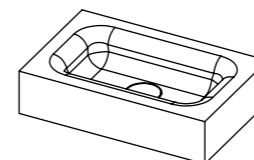

HBL17
w500 x d260 x h95mm
bowl w290 x d144 x h60mm

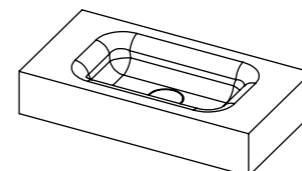

HBL18
w600 x d260 x h95mm
bowl w290 x d144 x h60mm

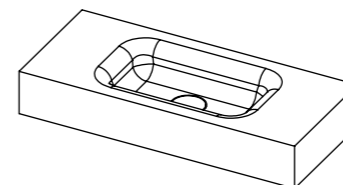

HBL19
w500 x d260 x h95mm
bowl w290 x d144 x h60mm

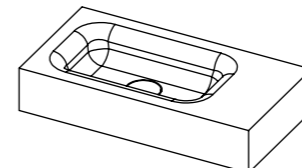

HBL20
w600 x d260 x h95mm
bowl w290 x d144 x h60mm

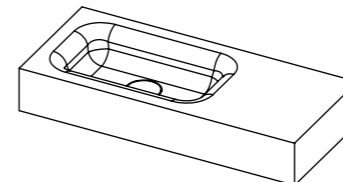

HBL21
w500 x d260 x h95mm
bowl w290 x d144 x h60mm

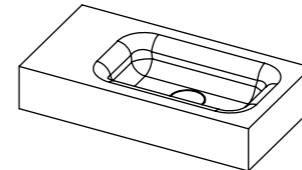

HBL22
w600 x d260 x h95mm
bowl w290 x d144 x h60mm

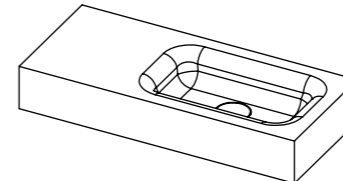

d260mm - with tap hole

HBL23
w500 x d260 x h95mm
bowl w290 x d144 x h60mm

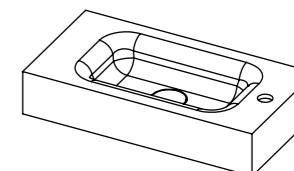

HBL24
w500 x d260 x h95mm
bowl w290 x d144 x h60mm

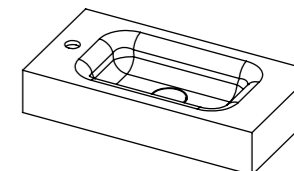

HBL25
w600 x d260 x h95mm
bowl w290 x d144 x h60mm

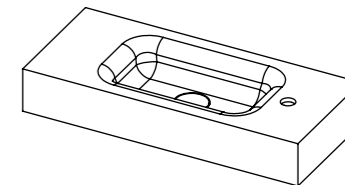

HBL26
w600 x d260 x h95mm
bowl w290 x d144 x h60mm

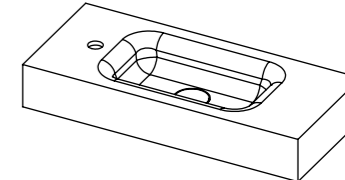

HBL27
w500 x d260 x h95mm
bowl w290 x d144 x h60mm

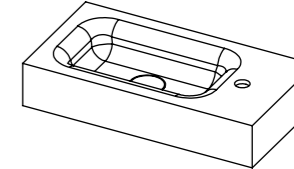

HBL28
w600 x d260 x h95mm
bowl w290 x d144 x h60mm

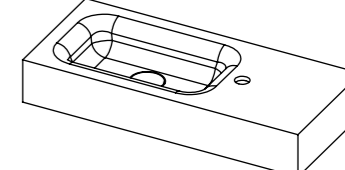

HBL29
w500 x d260 x h95mm
bowl w290 x d144 x h60mm

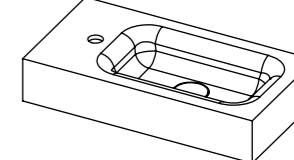

HBL30
w600 x d260 x h95mm
bowl w290 x d144 x h60mm

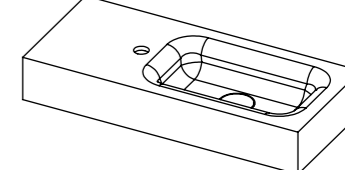

Handrinse layout

Fill in positions 1-5.

- ① max. 5000mm
- ② max. 400mm
- ③ min. 30mm
min. 75mm with tap hole
- ④ min. 30mm
- ⑤ min. 30mm
min. 75mm with tap hole

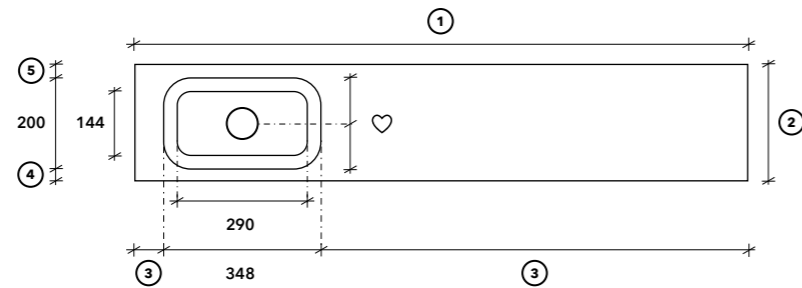

Edge

Blend handrinse always comes with a front and back edge. In order to conceal the bowl, Not Only White recommends an edge height of 95mm.

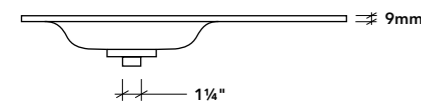

H9
9mm top sheet

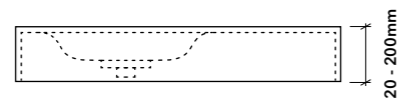

EH100
Edge 20 - 100mm high

EH150
Edge 101 - 150mm high

EH200
Edge 151 - 200mm high

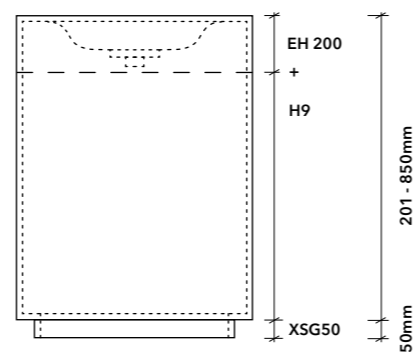

EH200 + remaining m² in H9
Edge 201 - 850mm high

XSG50
50mm plinth for floor-standing model

Bowls

CHBL29146
w348 x d200 x h60mm
rec. edge height 95mm



Drain type

Depending on how the handrinse basin needs to look and work, you can choose from different drain types for Blend handrinse.

- ① **FLUSH DRAIN**
free flow drain 

Blend handrinse bowls are standard equipped with our Flush drain. This drain allows water to flow through at all times and cannot be closed.

Flush drain is free of charge

- ② **DR72 DRAIN HOLE**
for a third party drain 

The DR72 drain hole is used for third party drains.

Not Only White recommends to use a free flow drain.

DR72 drain is free of charge

Overflow

An overflow is not possible.

Tap hole

If you need to fit a top-mounted tap, we can pre-drill the hole (code **HH35**).

Consider the space you would need to secure the tap with a tightening ring.

Top-mounted tap without overflow:

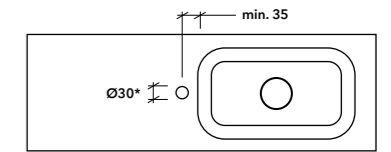

* Tap hole for UK 35mm

Mounting holes

To install a handrinse basin to the wall, Not Only White can provide mounting holes (code **OVHL**) in the back edge.

Handrinse basins up to 600mm need two holes. Any handrinse basin wider than 600mm, we advise to have an extra hole up to 1.2m and two extra holes up to 2m.

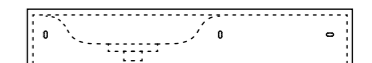

Please refer to **Brackets and ribs** for handrinse basins that need to be mounted on a cabinet and/or are deeper than 290mm. In this case mounting holes won't be needed.

Brackets and ribs

Please refer to page 11, where brackets and ribs are explained, to find out what type of support is needed for your washbasin.

Cut-outs and edge finishes

Please refer to page 10.

Materials and colors

Himacs White





The Form handrinse's linearity gives the collection its signature clean and serene look.

The rounded Flush drain, however, punctuates all the straight lines in a surprising and yet pleasing manner.

Design by Marike Andeweg

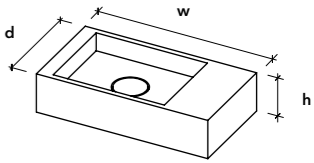

Specifications

- delivered with our Flush drain
- delivered as wall-mounted version including mounting holes in the back edge
- standard size tap hole Ø30mm; for UK Ø35mm
- Form handrinse Models are also available in top-mounted versions

d200mm - no tap hole

d200mm - with tap hole

HFM01
w300 x d200 x h85mm
bowl w240 x d176 x h40mm

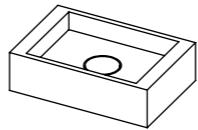

HFM07
w370 x d200 x h85mm
bowl w240 x d176 x h40mm

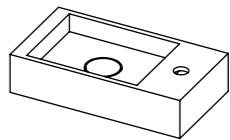

HFM02
w300 x d200 x h130mm
bowl w240 x d176 x h60mm

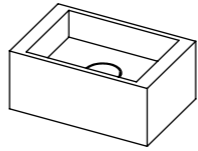

HFM08
w370 x d200 x h130mm
bowl w240 x d176 x h60mm

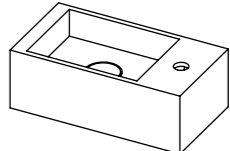

HFM03
w370 x d200 x h85mm
bowl w240 x d176 x h40mm

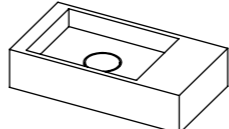

HFM09
w370 x d200 x h85mm
bowl w240 x d176 x h40mm

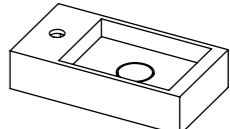

HFM04
w370 x d200 x h130mm
bowl w240 x d176 x h60mm

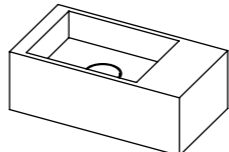

HFM10
w370 x d200 x h130mm
bowl w240 x d176 x h60mm

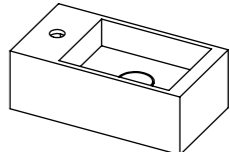

HFM05
w370 x d200 x h85mm
bowl w240 x d176 x h40mm

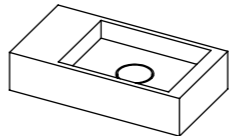

HFM06
w370 x d200 x h130mm
bowl w240 x d176 x h60mm

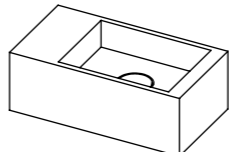

Materials and colors

Himacs White

Form Light handrinse



The Form Light handrinse's linearity gives the collection its signature clean and serene look.

The rounded Flush drain, however, punctuates all the straight lines in a surprising and yet pleasing manner.

Its depth of only 14 centimeters make it the perfect choice for small spaces.

Design by Marike Andeweg

Form Light handrinse Models

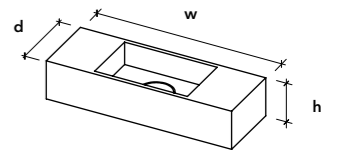

Specifications

- delivered with our Flush drain
- delivered as wall-mounted version including mounting holes in the back edge
- standard size tap hole Ø30mm; for UK Ø35mm
- Form Light handrinse Models are also available in top-mounted versions

	d140mm - no tap hole	d140mm - with tap hole
HFM11 w400 x d140 x h85mm bowl w200 x d122 x h50mm		
HFM12 w500 x d140 x h85mm bowl w200 x d122 x h50mm		
HFM13 w600 x d140 x h85mm bowl w200 x d122 x h50mm		
HFM14 w500 x d140 x h85mm bowl w200 x d122 x h50mm		
HFM15 w600 x d140 x h85mm bowl w200 x d122 x h50mm		
HFM16 w400 x d140 x h85mm bowl w200 x d122 x h50mm		

Materials and colors

Himacs White

Handrinse layout

Make a choice between Form or Form Light handrinse and fill in positions 1 and 2. After this define the size of the bowl. Go to page 113 for the bowl sizes.

FORM

- ① max. 2000mm
- ② min. 30mm
min. 80mm with tap hole

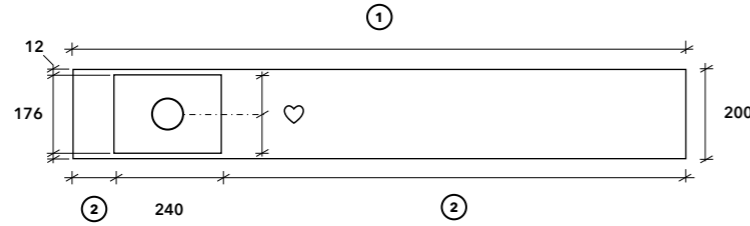

FORM LIGHT

- ① max. 2000mm
- ② min. 30mm
min. 80mm with tap hole

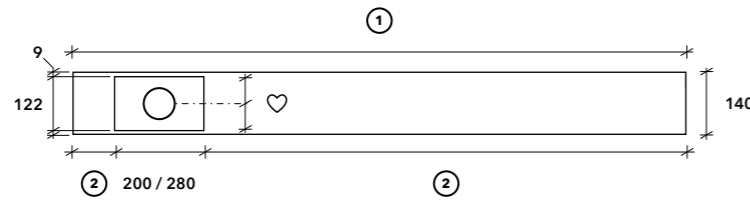

Edge

Form and Form Light handrinse always comes with a front and back edge. In order to conceal the bowl, Not Only White recommends an edge height as mentioned on the next page at the 'Bowls' section.

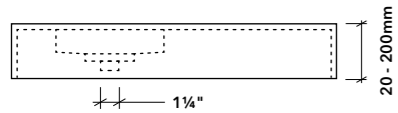

- EH100**
Edge 20 - 100mm high
- EH150**
Edge 101 - 150mm high
- EH200**
Edge 151 - 200mm high

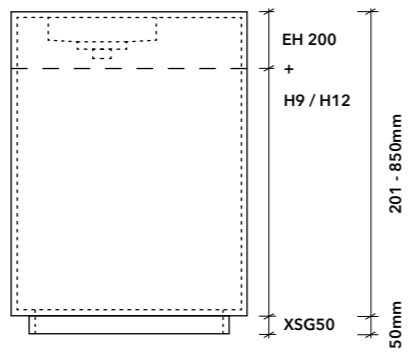

EH200 + remaining m² in H9 for Form Light
Edge 201 - 850mm high

EH200 + remaining m² in H12 for Form
Edge 201 - 850mm high

XSG50
50mm plinth for floor-standing model

Bowls

Form handrinse

CHF24174
w240x d176 x h40mm
rec. edge height 85mm



CHF24176
w240x d176 x h60mm
rec. edge height 105mm



CHF241710
w240x d176 x h100mm
rec. edge height 145mm



Form Light handrinse

CHF20125
w200 x d122 x h50mm
rec. edge height 95mm



CHF20128
w200 x d122 x h85mm
rec. edge height 130mm



CHF28128
w280 x d122 x h85mm
rec. edge height 130mm



Drain type

Depending on how the handrinse basin needs to look and work, you can choose from different drain types for Form handrinse.

- ① **FLUSH DRAIN**
free flow drain

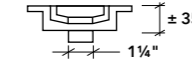

Form handrinse bowls are standard equipped with our Flush drain. This drain allows water to flow through at all times and cannot be closed.

Flush drain is free of charge

- ② **DR72 DRAIN HOLE**
for a third party drain

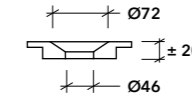

The DR72 drain hole is used for third party drains.

Not Only White recommends to use a free flow drain.

DR72 drain is free of charge

Overflow

An overflow is not possible.

Tap hole

If you need to fit a top-mounted tap, we can pre-drill the hole (code **HH35**).

Consider the space you would need to secure the tap with a tightening ring.

Top-mounted tap without overflow:

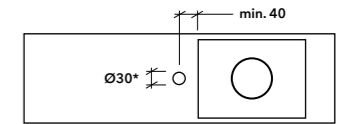

* Tap hole for UK 35mm

Mounting holes

To install a handrinse basin to the wall, Not Only White can provide mounting holes (code **OVHL**) in the back edge.

Handrinse basins up to 600mm need two holes. Any handrinse basin wider than 600mm, we advise to have an extra hole up to 1.2m and two extra holes up to 2m.

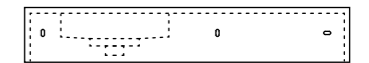

Please refer to **Ribs** for handrinse basins that need to be mounted on a cabinet. In this case mounting holes won't be needed.

Ribs

Please refer to page 11.

Cut-outs and edge finishes

Please refer to page 10.

Materials and colors

Himacs White



Kuub handrinse

Because of its practical dimensions, the Kuub handrinse is a good solution for toilets and cloakrooms. The slot drain gives the Kuub an interesting twist.

Design by Marike Andeweg



Kuub handrinse Models

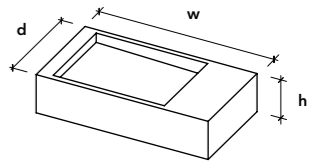

Specifications

- delivered with slot drain
- delivered as wall-mounted version including mounting holes in the back edge
- standard size tap hole Ø30mm; for UK Ø35mm
- Kuub handrinse Models are also available in top-mounted versions

d200mm - no tap hole

HKB01
w370 x d200 x h85mm
bowl w240 x d176 x h20mm

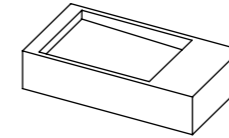

HKB02
w370 x d200 x h130mm
bowl w240 x d176 x h50mm

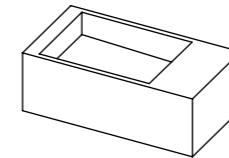

HKB03
w370 x d200 x h85mm
bowl w240 x d176 x h20mm

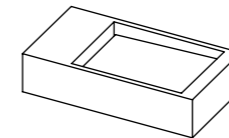

HKB04
w370 x d200 x h130mm
bowl w240 x d176 x h50mm

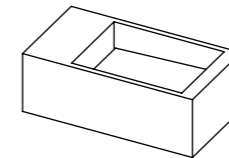

d200mm - with tap hole

HKB05
w370 x d200 x h85mm
bowl w240 x d176 x h20mm

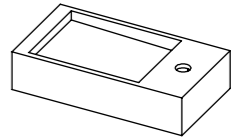

HKB06
w370 x d200 x h130mm
bowl w240 x d176 x h50mm

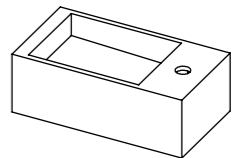

HKB07
w370 x d200 x h85mm
bowl w240 x d176 x h20mm

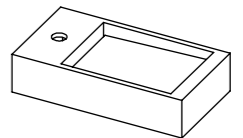

HKB08
w370 x d200 x h130mm
bowl w240 x d176 x h50mm

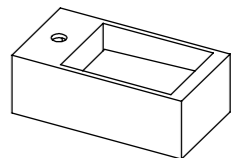

Materials and colors

Himacs White

Kuub Light handrinse



With its depth of only 14 centimeters, the compact dimensions of the Kuub Light handrinse make it the perfect choice for small spaces. The slot drain gives the Kuub Light handrinse an interesting twist.

Design by Marike Andeweg

Kuub Light handrinse Models

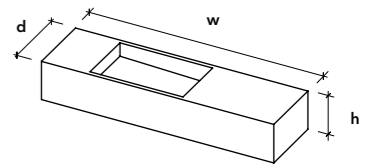

Specifications

- delivered with slot drain
- delivered as wall-mounted version including mounting holes in the back edge
- standard size tap hole Ø30mm; for UK Ø35mm
- Kuub Light handrinse Models are also available in top-mounted versions

d140mm - no tap hole

HKB09
w500 x d140 x h85mm
bowl w200 x d122 x h30mm

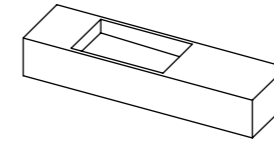

HKB10
w600 x d140 x h85mm
bowl w200 x d122 x h30mm

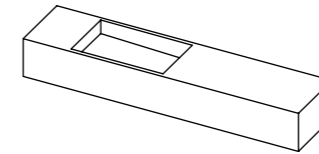

HKB11
w500 x d140 x h85mm
bowl w200 x d122 x h30mm

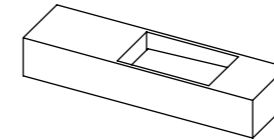

HKB12
w600 x d140 x h85mm
bowl w200 x d122 x h30mm

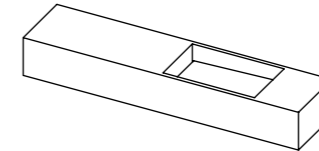

d140mm - with tap hole

HKB13
w500 x d140 x h85mm
bowl w200 x d122 x h30mm

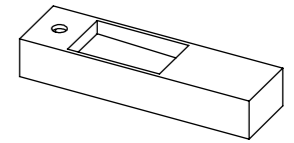

HKB14
w600 x d140 x h85mm
bowl w200 x d122 x h30mm

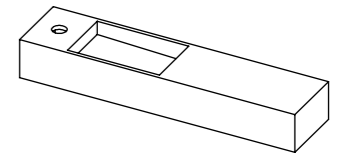

HKB15
w500 x d140 x h85mm
bowl w200 x d122 x h30mm

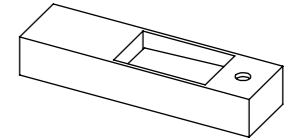

HKB16
w600 x d140 x h85mm
bowl w200 x d122 x h30mm

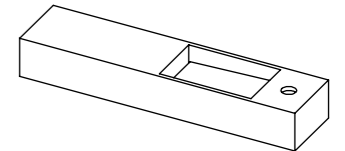

Materials and colors

Himacs White

Handrinse layout

Make a choice between Kuub or Kuub Light handrinse and fill in positions 1 and 2. After this define the size of the bowl. Go to page 119 for the bowl sizes.

KUUB

- ① max. 2000mm
- ② min. 30mm
min. 80mm with tap hole

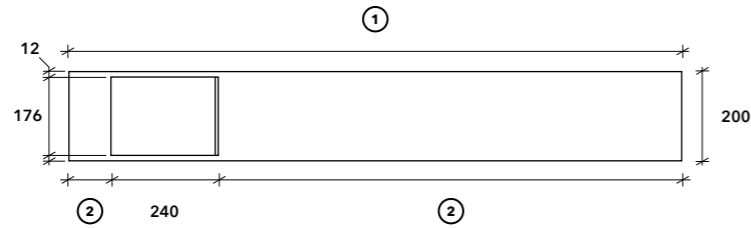

KUUB LIGHT

- ① max. 2000mm
- ② min. 30mm
min. 80mm with tap hole

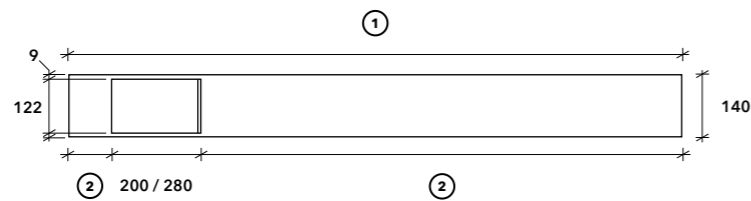

Edge

Kuub and Kuub Light handrinse always comes with a front and back edge. In order to conceal the bowl, Not Only White recommends an edge height as mentioned on the next page at the 'Bowls' section.

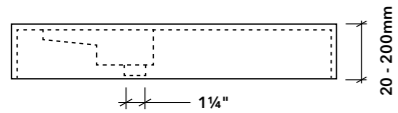

EH100
Edge 20 - 100mm high

EH150
Edge 101 - 150mm high

EH200
Edge 151 - 200mm high

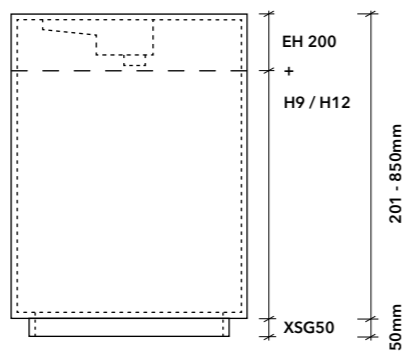

EH200 + remaining m² in H9 for Kuub Light
Edge 201 - 850mm high

EH200 + remaining m² in H12 for Kuub
Edge 201 - 850mm high

XSG50
50mm plinth for floor-standing model

Bowls

Kuub handrinse - drain to right

CHKB24172R
w240x d176 x h20mm
rec. edge height 85mm

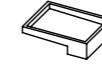

CHKB24175R
w240x d176 x h50mm
rec. edge height 115mm

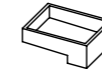

CHKB24178R
w240x d176 x h85mm
rec. edge height 150mm

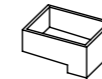

Kuub handrinse - drain to left

CHKB24172L
w240x d176 x h20mm
rec. edge height 85mm

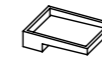

CHKB24175L
w240x d176 x h50mm
rec. edge height 115mm

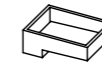

CHKB24178L
w240x d176 x h85mm
rec. edge height 150mm

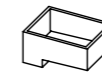

Kuub Light handrinse - drain to right

CHKBL20123R
w200x d122 x h30mm
rec. edge height 80mm

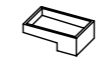

CHKBL20128R
w200x d122 x h85mm
rec. edge height 135mm



CHKBL28128R
w280x d122 x h85mm
rec. edge height 135mm

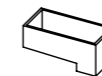

Kuub Light handrinse - drain to left

CHKBL20123L
w200x d122 x h30mm
rec. edge height 80mm

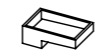

CHKBL20128L
w200x d122 x h85mm
rec. edge height 135mm



CHKBL28128L
w280x d122 x h85mm
rec. edge height 135mm



Drain type

Kuub basin is always supplied with a slot drain, as this gives Kuub its distinctive character.

Our slot drain cannot be closed.

Overflow

An overflow is not possible.

Tap hole

If you need to fit a top-mounted tap, we can pre-drill the hole (code **HH35**).

Consider the space you would need to secure the tap with a tightening ring.

Top-mounted tap without overflow:

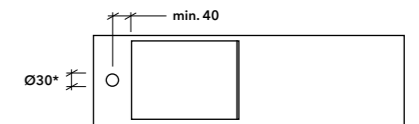

* Tap hole for UK 35mm

Mounting holes

To install a handrinse basin to the wall, Not Only White can provide mounting holes (code **OVHL**) in the back edge.

Handrinse basins up to 600mm need two holes. Any handrinse basin wider than 600mm, we advise to have an extra hole up to 1.2m and two extra holes up to 2m.



Please refer to **Ribs** for handrinse basins that need to be mounted on a cabinet. In this case mounting holes won't be needed.

Ribs

Please refer to page 11.

Cut-outs and edge finishes

Please refer to page 10.

Materials and colors

Himacs White



Noon handrinse



The smallest bowl in our Noon collection is the Noon handrinse. This handrinse basin can be used as a countertop model or wall-mounted by using our white powder coated bracket.

Noon handrinse is designed with its own matching white Himacs drain cover to gently merge with the soft rounded shape of the bowl.

Design by Marike Andeweg

Noon handrinse Models

Specifications

- HNN01 is top-mounted
- HNN02-04 comes with a white powder coated bracket
- HNN03-04 tap hole Ø30mm
- HNN10-14 tap hole Ø30mm; for UK Ø35mm

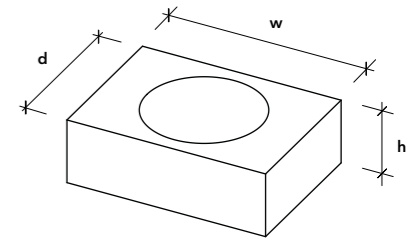
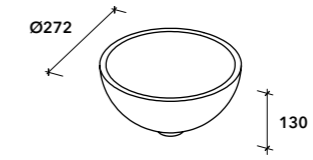

HNN01
Ø272 x h130mm



HNN10
w430 x d310 x h135mm
bowl Ø248 x h116mm

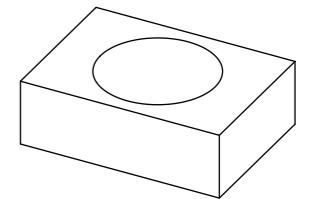

HNN02
Ø272 x h130mm

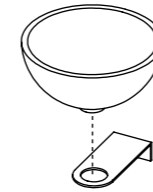

HNN11
w430 x d310 x h135mm
bowl Ø248 x h116mm

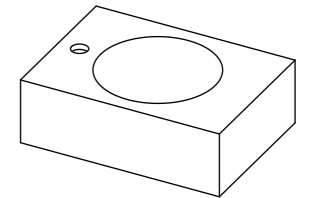

HNN03
Ø272 x h130mm

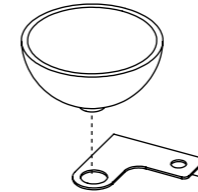

HNN12
w430 x d310 x h135mm
bowl Ø248 x h116mm

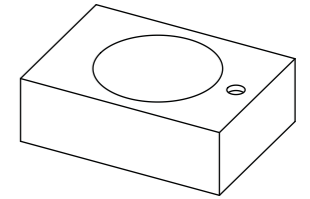

HNN04
Ø272 x h130mm

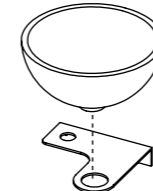

HNN13
w600 x d310 x h135mm
bowl Ø248 x h116mm

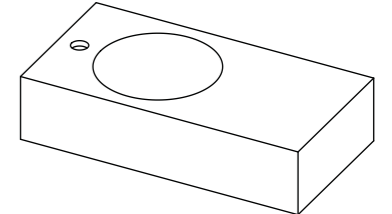

HNN14
w600 x d310 x h135mm
bowl Ø248 x h116mm

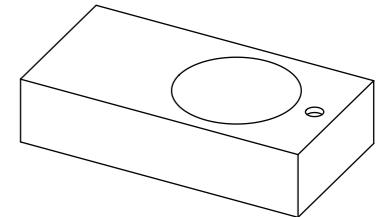

Materials and colors

- Himacs** ○ White
- Steel** ○ White powder coated

Handrinse layout

Fill in positions 1-5.

- ① max. 5000mm
- ② max. 400mm
- ③ min. 35mm
min. 90mm with tap hole
- ④ min. 30mm
- ⑤ min. 30mm
min. 80mm with tap hole

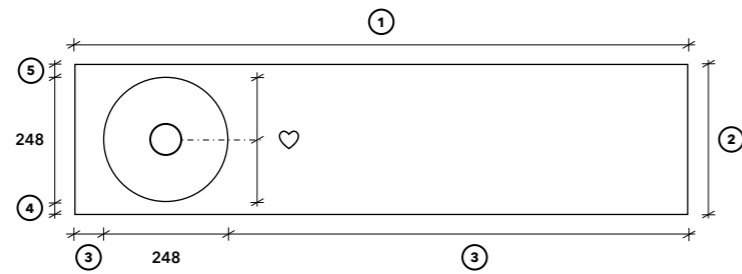

Edge

Noon handrinse can come with a front and back edge. In order to conceal the bowl, Not Only White recommends an edge height of 135mm.

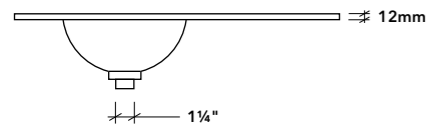

H12
12mm top sheet

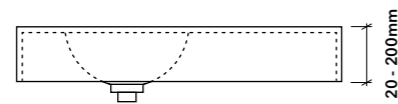

EH100
Edge 20 - 100mm high

EH150
Edge 101 - 150mm high

EH200
Edge 151 - 200mm high

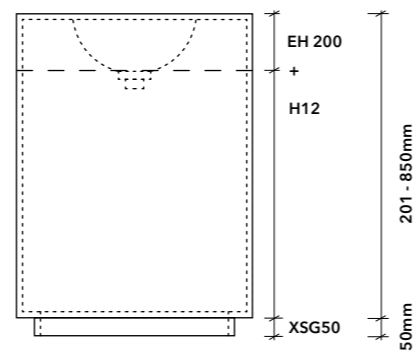

EH200 + remaining m² in H12
Edge 201 - 850mm high

XSG50
50mm plinth for floor-standing model

Bowls

CHNN01
Ø248 x h116mm
rec. edge height 135mm



Drain type

Depending on how the handrinse basin needs to look and work, you can choose from different drain types for Noon handrinse.

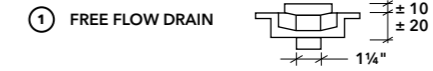

Noon handrinse bowls are standard equipped with a free flow drain. This drain allows water to flow through at all times and cannot be closed.

Free flow drain is free of charge



The DR72 drain hole is used for third party drains.

Not Only White recommends to use a free flow drain.

DR72 drain is free of charge

Overflow

An overflow is not possible.

Tap hole

If you need to fit a top-mounted tap, we can pre-drill the hole (code **HH35**).

Consider the space you would need to secure the tap with a tightening ring.

Top-mounted tap without overflow:

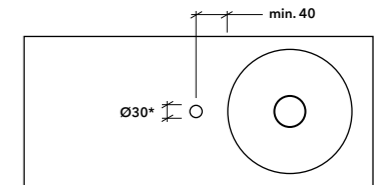

* Tap hole for UK Ø35mm

Brackets and ribs

Please refer to page 11, where brackets and ribs are explained, to find out what type of support is needed for your washbasin.

Cut-outs and edge finishes

Please refer to page 10.

Materials and colors

Himacs White



Base basin



Nest countertop basin



Axis bath



Blend basin



Noon basin



Mono basin

COLOFON

PUBLISHER

Not Only White B.V.

PRODUCT DESIGN

Marike Andeweg Base, Basq, Blend,
Box, Flat, Form, Frame, Fuse, Kuub, Leaf,
Mono, Noon and Unit

Joost van der Vecht Aim, Fall and Scape

Curated by Marike Andeweg Axis, Ease,
Fine, Loop, Muse, Nest, Pose and Still

COVER ILLUSTRATION

Maartje van den Noort

PRINTING

Van Berkum Graphic Solutions

Not Only White B.V. © 2022

16th edition, August 2022

The colors in this catalogue are by way of
illustration only, and may differ from the
actual colors.

Not Only White B.V. reserves the rights
to alter materials, characteristics and
dimensions without prior notice.

All dimensions are in millimeters (mm)
unless mentioned otherwise.

Modifications and printing errors
reserved.

All models © by Not Only White B.V.

Not Only White is a registered brand
name.

Nothing in this catalogue may be copied
without the written consent of Not Only
White B.V.

Head office:

Not Only White B.V.
IJslandstraat 8 bus B2
8400 Oostend
Belgium

tel +32 (0)50 800 290

Design studio:

Not Only White B.V.
Stuyvesantstraat 17-HS
1058 AJ Amsterdam
The Netherlands

tel +31 (0)20 427 79 47

info@notonlywhite.com
notonlywhite.com

