



Form



The Form's linearity gives the collection its signature clean and serene look. The rounded Flush drain, however, punctuates all the straight lines in a surprising and yet pleasing manner.

Next to the basin a lower plateau can be integrated to create a platform for a mounted tap or a space to place soap or other bathroom accessories.

Design by Marike Andeweg

○ White Himacs



Washbasin layout

Make a choice between a single or double bowl washbasin and fill in positions 1-5 or 1-6 accordingly. Next step is to define the size of the bowl(s) indicated by the - symbol. Go to page 46 for Form bowl sizes.

SINGLE

- bowl width
- ① max. 5000mm
- ② max. 550mm
- ③ min. 35mm
- ④ min. 30mm
- ⑤ min. 30mm
min. 50mm with overflow
min. 80mm with tap hole
min. 120mm with tap hole + overflow

Note: when ordering only a top with bowl(s), sizes 3, 4 and 5 need to be adjusted according to the cabinet construction.

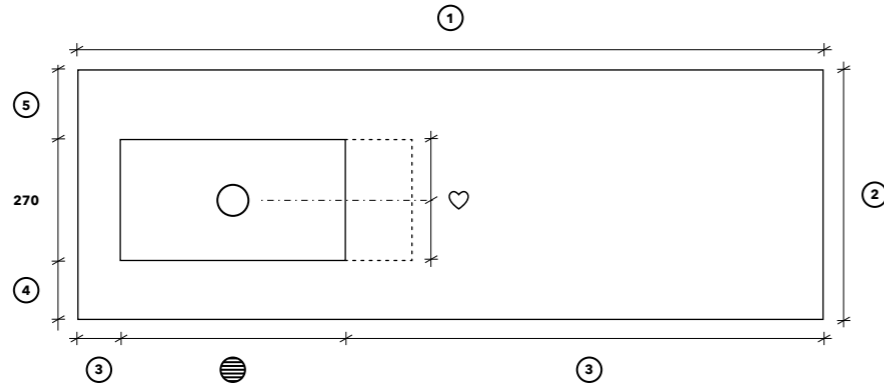

DOUBLE

- bowl width
- ① max. 5000mm
- ② max. 500mm
- ③ min. 35mm
- ④ min. 30mm
- ⑤ min. 30mm
min. 50mm with overflow
min. 80mm with tap hole
min. 120mm with tap hole + overflow
- ⑥ min. 50mm

Note: when ordering only a top with bowl(s), sizes 3, 4 and 5 need to be adjusted according to the cabinet construction.

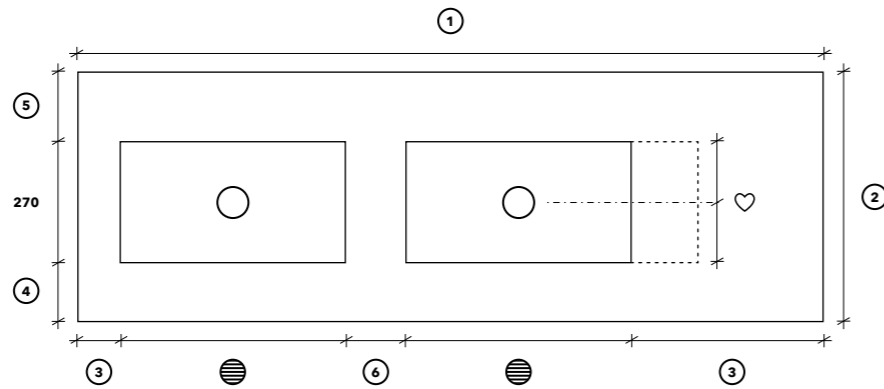

Edge

Form washbasin can be supplied with a 12mm top or with an edge from 20mm up to 900mm. In order to conceal the bowl, Not Only White recommends an edge height as mentioned on page 46 at the 'Bowls' section.

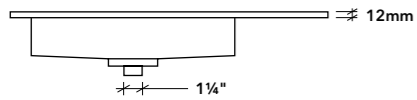

H12
12mm top sheet

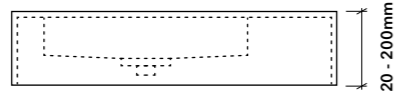

EH100
Edge 20 - 100mm high

EH150
Edge 101 - 150mm high

EH200
Edge 151 - 200mm high

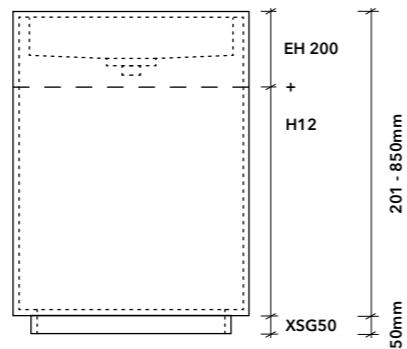

EH200 + remaining m² in H12
Edge 201 - 850mm high

XSG50
50mm plinth for floor-standing model

Tap hole

If you need to fit a top-mounted tap, we can pre-drill the hole (code **HH35**).

Consider the space you would need to secure the tap with a tightening ring.

Top-mounted tap without overflow:

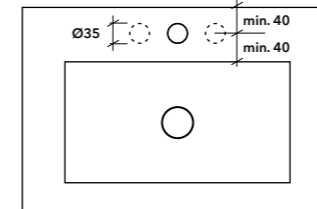

Top-mounted tap with overflow:

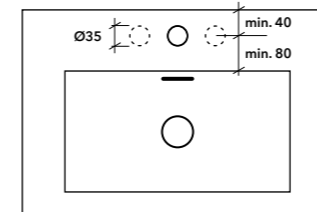

Basq trays

Form washbasin can be supplied with a plateau on the side for Basq trays. Please refer to page 10 and 45.

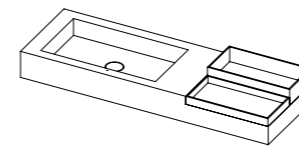

Cut-outs and edge finishes

Please refer to page 10.

Form plateau

Form can be delivered with a plateau next to right or the left side of the bowl. Please refer to page 10.

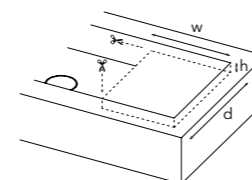

Drain type

Depending on how the washbasin needs to look and work you can choose from different drain types for Form.

- ① **FLUSH DRAIN**
free flow drain

Form bowls are standard equipped with our Flush drain. This drain allows water to flow through at all times and cannot be closed.

Flush drain is free of charge

- ② **POP-DOWN DRAIN**
closable drain

Our Pop-down drain has the same aesthetic as the Flush drain but it can be pressed down to close the drain.

Pop-down drain is calculated per bowl

For use with the Pop-down drain, Not Only White recommends to equip the bowl with an overflow.

- ③ **DR72 DRAIN HOLE**
for a third party drain

The DR72 drain hole is used for third party drains, both closable and non-closable.

DR72 drain is free of charge

Not Only White recommends to pair a third party closable drain with an overflow.

Note: when choosing a pop-down drain we recommend an overflow and extra edge height of 45mm. With a pop-down drain only we recommend an extra edge height of 15mm.

Brackets and ribs

Please refer to page 11, where brackets and ribs are explained, to find out what type of support is needed for your washbasin.

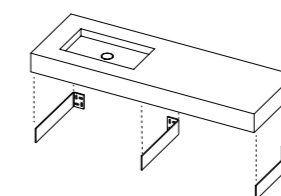

Overflow

An overflow (code **OH50**) is used for bowls equipped with a closable drain.

The overflow drain tube needs 50mm at the back of the washbasin to fit.

The overflow ring, that drains excess water into the drain, adds 30mm of height underneath the basin drain.

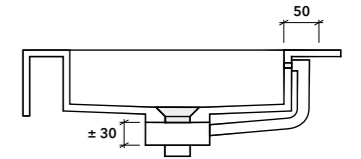

Integrated backsplash

Not Only White offers an integrated backsplash on Form washbasins (code **CSP90H**) with a maximum height of 90mm.

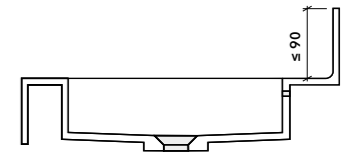

Note that a backsplash with a height over 90mm will be supplied as a separate piece without a radius edge.

Separate backsplash is calculated per m²

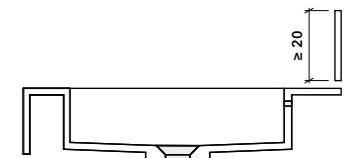

Materials and colors

Himacs White

Form

Form Custom Made

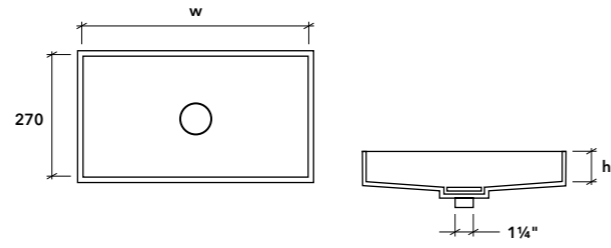

Bowls - depth 270mm

Form bowls can only be ordered with at least a top

w270mm

CFM27050
w270 x d270 x h50mm
rec. edge height 90mm

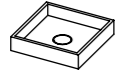

CFM27075
w270 x d270 x h75mm
rec. edge height 115mm

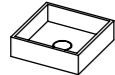

CFM270100
w270 x d270 x h100mm
rec. edge height 140mm



w500mm

CFM50050
w500 x d270 x h50mm
rec. edge height 95mm

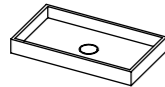

CFM50075
w500 x d270 x h75mm
rec. edge height 120mm

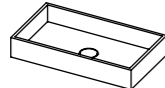

CFM500100
w500 x d270 x h100mm
rec. edge height 145mm

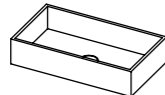

w1000mm

CFM100050
w1000 x d270 x h100mm
rec. edge height 95mm

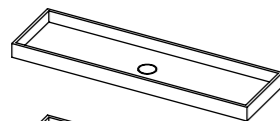

CFM100075
w1000 x d270 x h75mm
rec. edge height 125mm



CFM1000100
w1000 x d270 x h100mm
rec. edge height 150mm

