



Mono



The Mono collection arised from one beautifully oval shaped bowl. Its organic form draws you into the bowl, ready to freshen up. The linear top gives the Mono a timeless modern look and feel. This collection is suitable for many types of projects. It just feels right at home, in an office or a hotel.

Design by Marike Andeweg

○ White Himacs



Washbasin layout

Make a choice between a single or double bowl washbasin and fill in positions 1-5 or 1-6 accordingly.

SINGLE

- w450 x d300 mm
- ① max. 5000mm
- ② max. 550mm
- ③ min. 35mm
- ④ min. 30mm
- ⑤ min. 30mm
min. 50mm with overflow
min. 80mm with tap hole
min. 120mm with tap hole + overflow

Note: when ordering only a top with bowl(s), sizes 3, 4 and 5 need to be adjusted according to the cabinet construction.

DOUBLE

- w450 x d300 mm
- ① max. 5000mm
- ② max. 550mm
- ③ min. 35mm
- ④ min. 30mm
- ⑤ min. 30mm
min. 50mm with overflow
min. 80mm with tap hole
min. 120mm with tap hole + overflow
- ⑥ min. 50mm

Note: when ordering only a top with bowl(s), sizes 3, 4 and 5 need to be adjusted according to the cabinet construction.

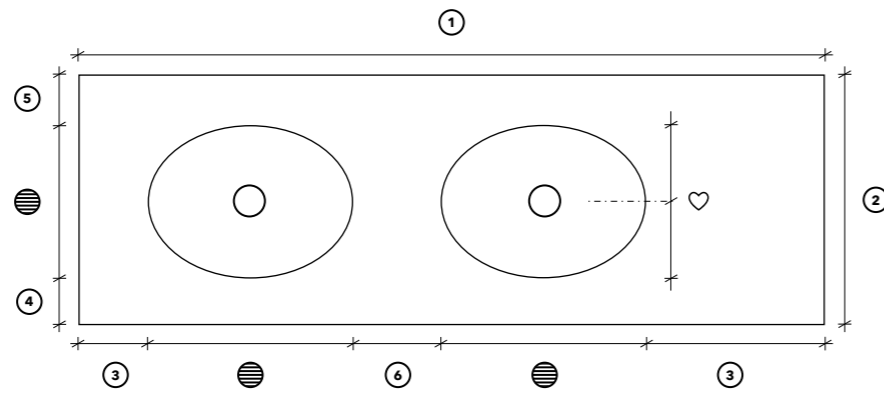
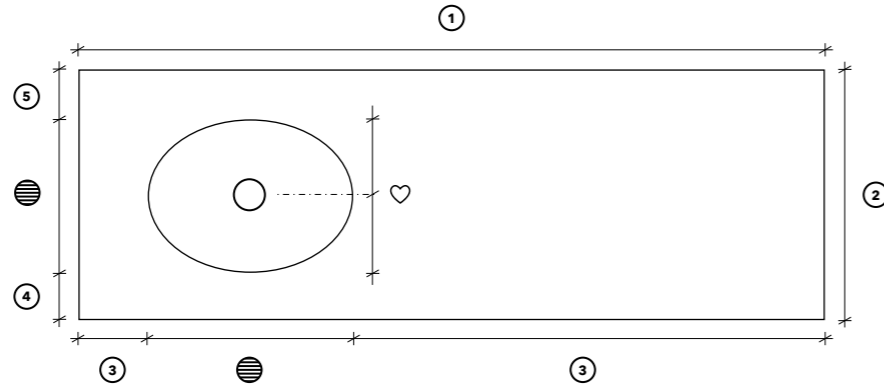

Edge

Mono washbasin can be supplied with a 12mm top or with an edge from 20mm up to 900mm.

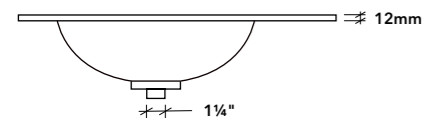

H12
12mm top sheet

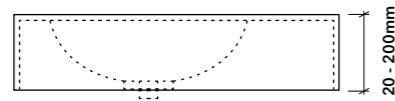

EH100
Edge 20 - 100mm high

EH150
Edge 101 - 150mm high

EH200
Edge 151 - 200mm high

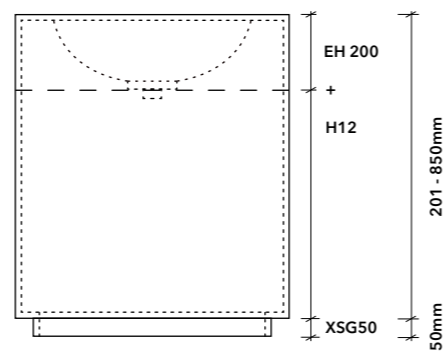

EH200 + remaining m² in H12
Edge 201 - 850mm high

XSG50
50mm plinth for floor-standing model

Bowls

The Mono bowl can only be ordered with at least a top.

CMO450
w450 x d300 x h120mm
rec. edge height 135 mm



Tap hole

If you need to fit a top-mounted tap, we can pre-drill the hole (code HH35).

Consider the space you would need to secure the tap with a tightening ring.

Top-mounted tap without overflow:

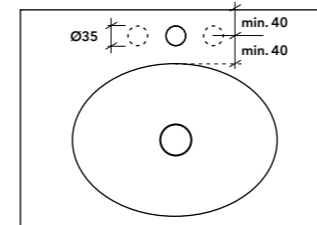

Top-mounted tap with overflow:

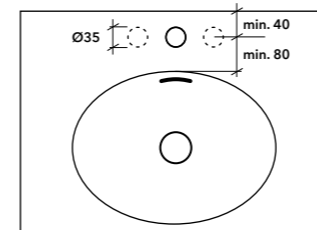

Cut-outs and edge finishes

Please refer to page 10.

Materials and colors

Himacs ○ White

Drain type

Depending on how the washbasin needs to look and work, you can choose from different drain types for Mono.

- ① **FLUSH DRAIN**
free flow drain

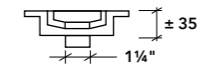

Mono bowls are standard equipped with our Flush drain. This drain allows water to flow through at all times and cannot be closed.

Flush drain is free of charge

- ② **POP-DOWN DRAIN**
closable drain

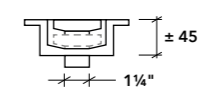

Our Pop-down drain has the same aesthetic as the Flush drain but it can be pressed down to close the drain.

Pop-down drain is calculated per bowl

For use with the Pop-down drain, Not Only White recommends to equip the bowl with an overflow.

- ③ **DR72 DRAIN HOLE**
for a third party drain

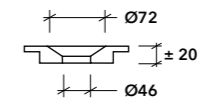

The DR72 drain hole is used for third party drains, both closable and non-closable.

DR72 drain is free of charge

Not Only White recommends to pair a third party closable drain with an overflow.

Note: when choosing a pop-down drain we recommend an overflow and extra edge height of 45mm. With a pop-down drain only we recommend an extra edge height of 15mm.

Basq trays

Mono washbasin can be supplied with a plateau on the side for Basq trays. Please refer to page 10 and 45.

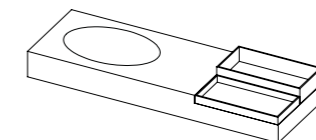

Overflow

An overflow (code OH50) is used for bowls equipped with a closable drain.

The overflow drain tube needs 50mm at the back of the washbasin to fit.

The overflow ring, that drains excess water into the drain, adds 30mm of height underneath the basin drain.

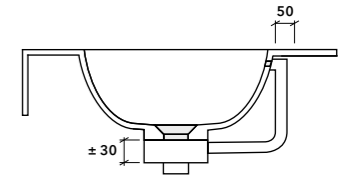

Integrated backsplash

Not Only White offers an integrated backsplash on Base washbasins (code CSP90H) with a maximum height of 90mm.

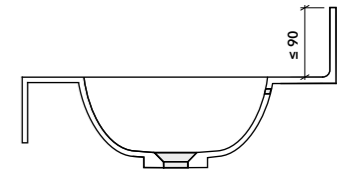

Note that a backsplash with a height over 90mm will be supplied as a separate piece without a radius edge.

Separate backsplash is calculated per m²

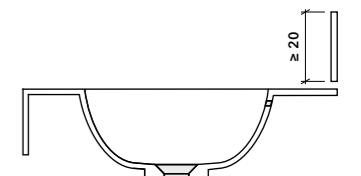

Brackets and ribs

Please refer to page 11, where brackets and ribs are explained, to find out what type of support is needed for your washbasin.

