

# NOT ONLY WHITE®

---

Not Only White's collection of bathroom products is designed and curated to create simple pleasures in life. Brought back to the basics, yet always with a touch of warmth and elegance.

Our collection is inviting to touch, as how it should be in a bathroom. A bathroom is a sensory and sensual space. A space where you feel at ease from the moment you step in. To refresh for just a few minutes or fully immerse and lose track of time.

We realize options are limitless these days and every decision takes your time. Therefor at Not Only White we aim to keep it simple and clear. We believe in luxury, but always sophisticated and modest.

Not Only White is dedicated to make sure our collections are well-balanced, refined and meet your needs. This way we can create simple pleasures for you.

Refined luxury, simple pleasures.





Fine bath



Frame basin



Still countertop basin



Nest Soft Touch countertop basin

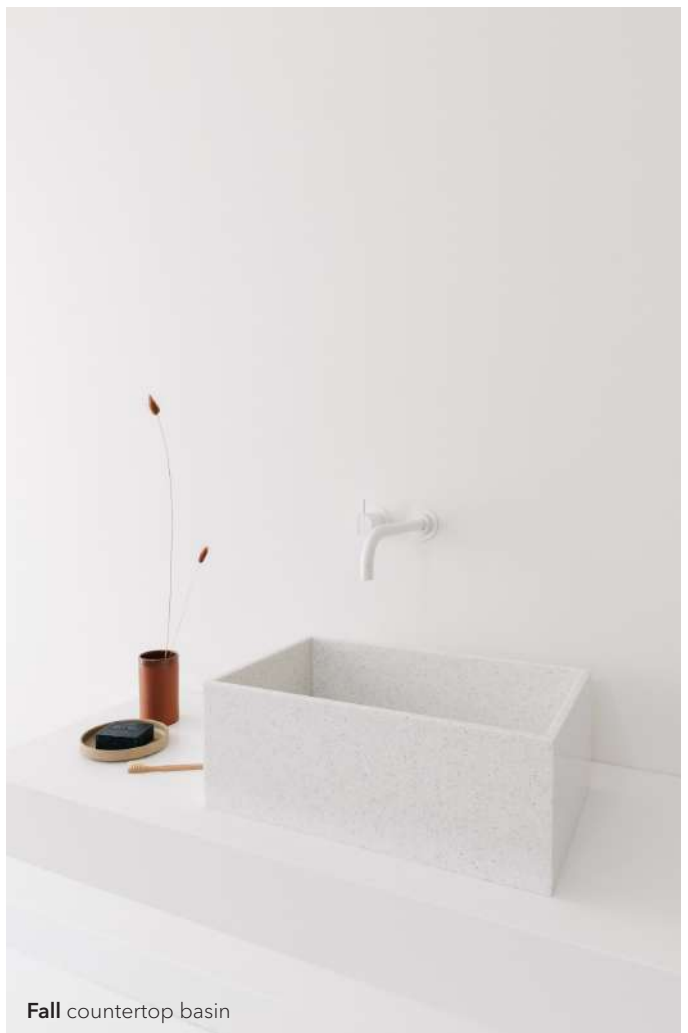

Fall countertop basin



Muse Palette bath



Still Palette countertop basin



Pose Palette basin



Scape basin



Loop Soft Touch bath



# Content

Custom Made by Not Only White explained	6
Materials and colors	9
Palette finish	9
Soft Touch coating	9

## **Custom Made basins**

---

Base	13
Blend	19
Box	23
Form	27
Mono	33
Noon	37
Unit cabinet	41
Basq tray	45
Flat shelf	47

## **Basins**

---

Aim	49
Box countertop	53
Fall countertop	55
Frame	59
Fuse	63
Nest countertop	67
Noon countertop	71
Pose	73
Scape	79
Still countertop	83

## **Tapware**

---

Leaf single lever tap	91
Leaf spout with mixer	93

## **Baths**

---

Axis	97
Ease	99
Fine	101
Loop	107
Muse	111
Bath tray for Axis and Loop	113

## **Handrinse basins**

---

<b>Base handrinse</b>	
Models	115
Custom	120
<b>Base Light handrinse</b>	
Models	117
Custom	120
<b>Base Bold handrinse</b>	
Models	119
Custom	120
<b>Blend handrinse</b>	
Models	123
Custom	126
<b>Form handrinse</b>	
Models	129
Custom	132
<b>Form Light handrinse</b>	
Models	131
Custom	132
<b>Kuub handrinse</b>	
Models	135
Custom	138
<b>Kuub Light handrinse</b>	
Models	137
Custom	138
<b>Noon handrinse</b>	
Models	141
Custom	142

# Custom Made by Not Only White explained



With Not Only White, you can create the perfect solution for every bathroom or toilet, be it at home, in a hotel, restaurant, office, etc. This is achieved by having our products made to order according to the client's wishes, based on our collection elements.

Our *Custom Made* system provides the flexibility to adjust the washbasin's width, depth and height accordingly to the client's needs and wishes. Even the position and number of bowls can easily be modified. *Custom Made* also means having the ability to leave out what is unnecessary. In the case that a wall covers one side edge of a washbasin, this edge is not visible and thus not needed. It will be left out in the calculation of the product pricing.

In the next pages, our *Custom Made* system will be explained in detail.

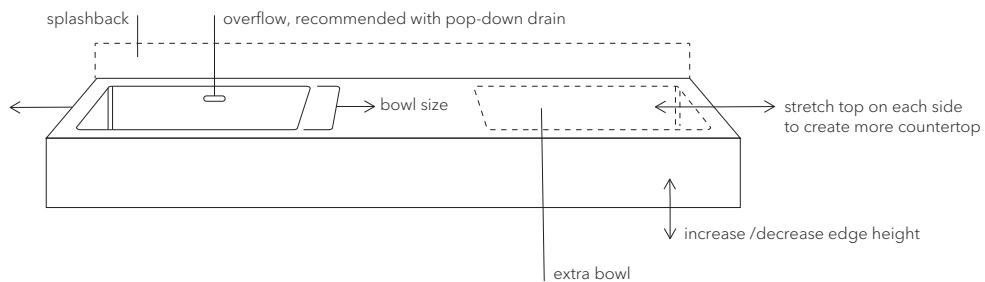

## 1. Choose the bowl design

The Not Only White collection offers a range of 6 different designs: Base, Blend, Box, Form, Mono and Noon.

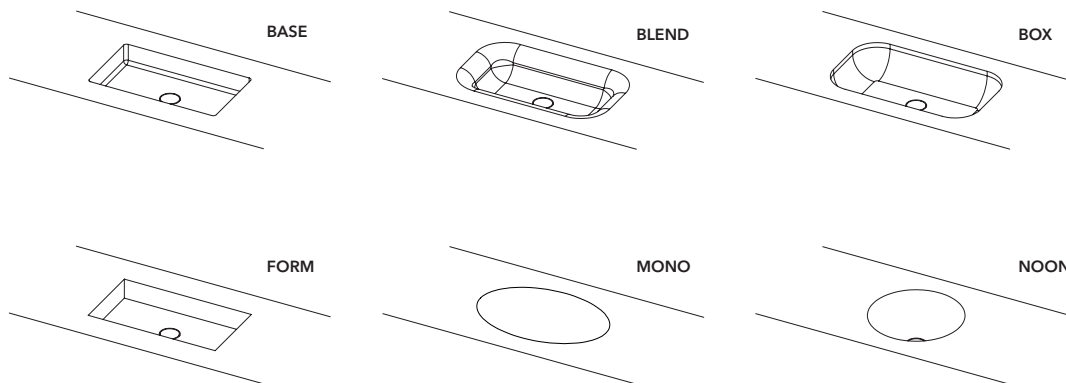

---

## 2. Choose the composition

The next step is to define the composition. Our collection offers washbasins in many variations.

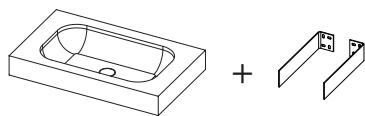

### Washbasin wall-mounted

The washbasin is mounted to the wall with brackets.

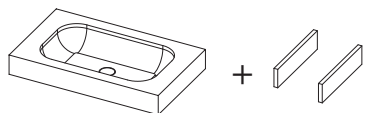

### Washbasin top-mounted

The washbasin has to be mounted on top of a shelf or cabinet and is supplied with fixed plywood ribs for support.

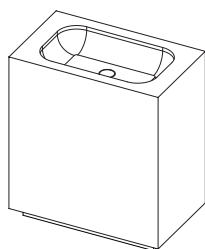

### Washbasin floor-standing

The washbasin has a 50mm high plinth and 4 adjustable feet.

## 4 ways to combine a custom made washbasin with a cabinet:

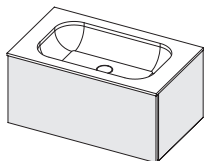

### Washbasin in cabinet

The thin washbasin top is directly supported by the cabinet body and the bowl sits inside the cabinet.

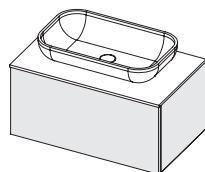

### Countertop washbasin on cabinet

The washbasin is a countertop model and sits on top of a cabinet (or shelf). Not Only White offers 4 countertop washbasins: Box, Nest, Noon and Still.

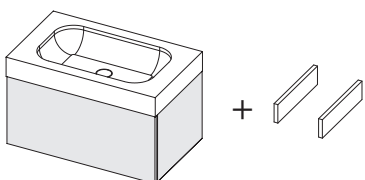

### Washbasin on cabinet

The washbasin sits directly on top of the cabinet. Ribs are added underneath the washbasin. These ribs strengthen the washbasin and are necessary to install the washbasin onto the cabinet.

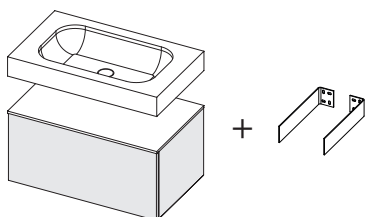

### Washbasin separate from cabinet

The washbasin is supported by brackets.

### 3. Define the dimensions

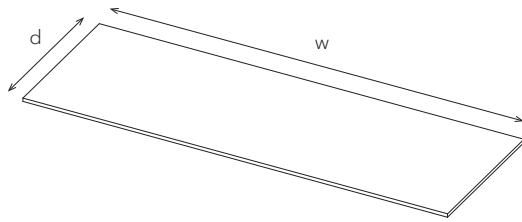

#### Top

Whether you want a wall-to-wall or a smaller sized 'free-hanging' washbasin, start with deciding on the dimensions of the top. This will also determine the size and number of bowls that the top can accommodate.

Top is calculated in m<sup>2</sup>

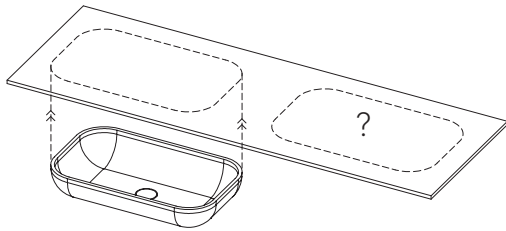

#### Bowl(s)

Now that you know the overall dimensions, the next step is to determine the bowl(s) of your choice (e.g. Base, Blend, etc....) to create the look of your Custom basin.

Not Only White offers multiple sizes for most bowl designs. You have the choice of fitting **one or multiple bowls** in your top.

Bowls are calculated per piece

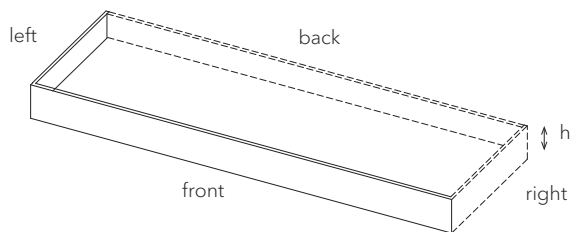

#### Edge

Edges can be added to the top and vary from 20mm up to 900mm high. A washbasin with a 900mm high edge is what we call a floor-standing model.

Have a look below which edges are necessary in your situation.

Edges up to 200mm high are calculated per running meter

#### SITUATIONS

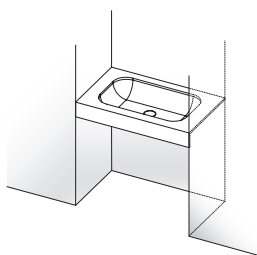

ENCLOSED  
FRONT EDGE ONLY

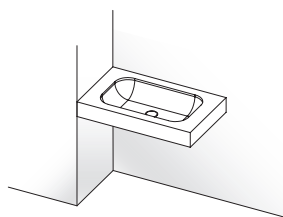

WALL ON LEFT SIDE  
FRONT + RIGHT EDGE

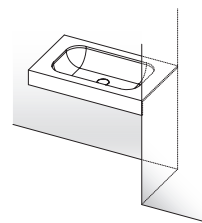

WALL ON RIGHT SIDE  
FRONT + LEFT EDGE

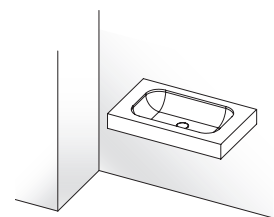

FREE HANGING  
FRONT + LEFT + RIGHT EDGE

## 4. Continue with more options

### Tap hole

If you need to fit a top-mounted tap, we can pre-drill the hole (code **HH35**).

**Tap hole is calculated per bowl**

Consider the space you would need to secure the tap with a tightening ring.

**Top-mounted tap without overflow:**

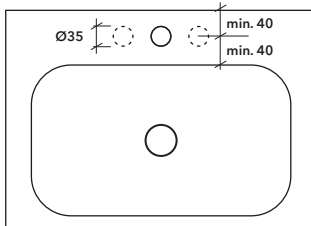

**Top-mounted tap with overflow:**

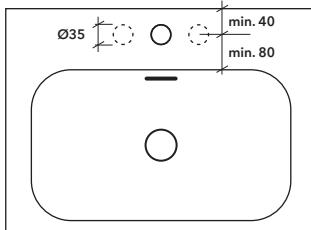

### Overflow

An overflow (code **OH50**) is used for bowls equipped with a closable drain.

**Overflow is calculated per bowl.**

The overflow drain tube needs at least 50mm at the back of the washbasin to fit.

The overflow ring, that drains excess water into the drain, adds 30mm of height underneath the basin drain.

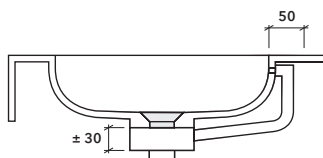

Side view

### Drain type

Depending on how the washbasin needs to look and work, you can choose from different drain types for Base, Blend, Box, Form, Mono and Noon.

#### 1 FLUSH DRAIN free flow drain

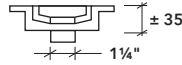

All Himacs bowls (except for Kuub handrinse and Scape) are standard equipped with our Flush drain. This drain allows water to flow through at all times and cannot be closed.

**Flush drain is free of charge**

#### 2 POP-DOWN DRAIN closable drain

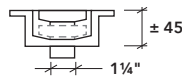

Our Pop-down drain has the same aesthetic as the Flush drain but it can be pressed down to close the drain.

**Pop-down drain is calculated per bowl**

Not Only White recommends to pair the Pop-down drain with an overflow.

#### 3 DR72 DRAIN HOLE for a third party drain

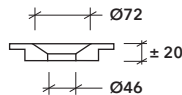

The DR72 drain hole is used for third party drains, both closable and non-closable.

**DR72 drain is free of charge**

Not Only White recommends to pair a third party closable drain with an overflow.

### Materials and colors

Base, Blend, Box, Flat, Form, Frame, Kuub, Mono and Noon are made of S28 Alpine White Himacs®.

Accessory range Basq and the bath trays are made of Himacs® and come in different colors. Basq also comes in Natural Oak veneer.

Axis, Ease, Fine, Loop and Muse baths as well as Aim, Fuse, Nest, Pose and Still washbasins are made of white Velluto® biobased.

Aim is available with Soft Touch coating on the outside in RAL 9005.

Fuse is available with Soft Touch coating on the outside in RAL 5008 and RAL 7044.

Pose, Nest and Still washbasins as well as Ease, Fine, Loop and Muse baths are available with Soft Touch coating or Palette finish.

Fall is available in S28 Alpine White, G004 White Quartz, G038 Sea Oat Quartz and G100 Peanut Butter Himacs®.

Scape is available in S28 Alpine White and S22 Black Himacs®.

### Palette finish



Palette is a two-component acrylic-polyurethane and pigmented paint, which is applied on our Velluto® biobased solid surface collections. On the inside and outside.

Palette is easy to clean and UV resistant. Because of the availability in all NCS and RAL colors, design professionals can create a unique and distinctive aesthetic appearance in both residential and commercial projects.

### Soft Touch coating



Soft Touch finish consists of two layers. The first layer is a two-component acrylic matt base coating with excellent adhesion and light resistance. The second layer is a two-component transparent polyurethane coating with soft touch effect in order to create that distinctive homogeneous, velvety tactile experience.

Because of the availability in all NCS and RAL colors, design professionals can create a unique and distinctive aesthetic appearance in both residential and commercial projects.

## 5. Cut-outs and edge finishing

### Edge cut-out

Edge cut-outs are calculated per piece

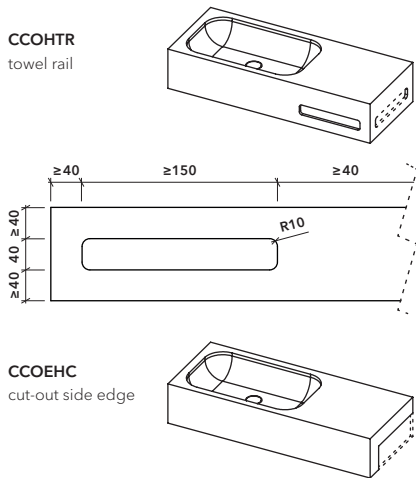

### Integrated backsplash

An integrated backsplash can be applied on all Himacs washbasins (code **CSP90H**) with a maximum height of 90mm.

Integrated backsplash is calculated per running meter

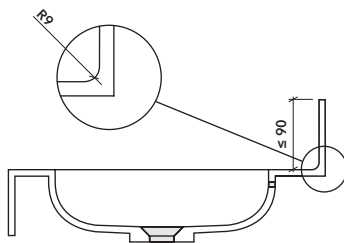

Note that a backsplash with a height over 90mm will be supplied as a separate piece without a radius edge.

Separate backsplash is calculated per m<sup>2</sup>

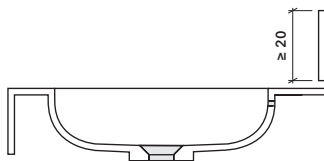

### Recessed edge

For washbasins placed on cabinets with recessed fronts, a 50mm recessed edge (code **CRE50**) is available to close off a part of the underside.

Recessed edge is calculated per running meter

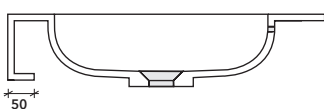

### Top cut-out

Top cut-outs are calculated per piece

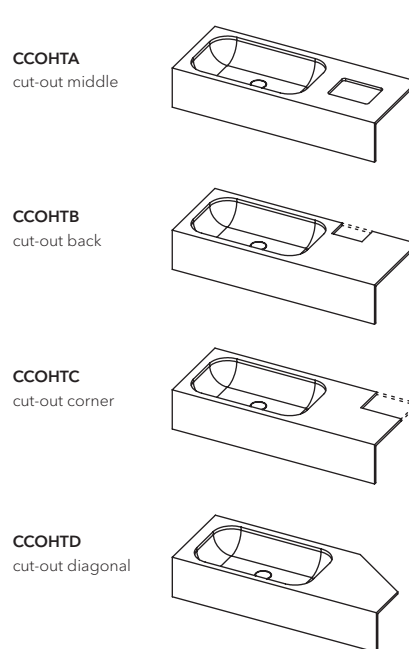

### Unit

Add the Unit for some extra storage space. Calculate the washbasin without accounting for the Unit. Then add the price of your chosen Unit size.

To view the offered Unit sizes go to page 41.

Side Unit



Front Unit



Bottom Unit

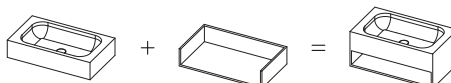

Top Unit

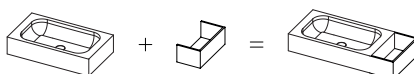

### Plateau for Basq tray

To create a plateau (code **XPL**) for the Basq tray, the edge on one or both sides of the washbasin can be lowered.

Calculate the washbasin without accounting for the plateau and then add the cost of code XPL.

The width (w) and height (h) are to be defined by you.

Lower side plateau is calculated per piece, regardless of its width and height

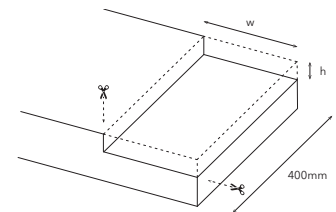

### Basq tray

The Basq trays can be ordered in 7mm Natural Oak veneer or 12mm Himacs. See page 125 for all information about the Basq trays.

**CBX20040(-NO)**  
w200 x d400 x h40mm

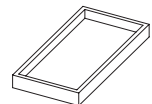

**CBX20080(-NO)**  
w200 x d400 x h80mm

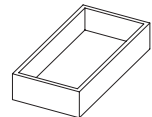

**CBX40040(-NO)**  
w400 x d400 x h40mm

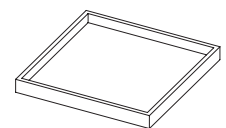

### Form plateau

To create a plateau (code **XFP**) in the Form basin on the left or right side of the bowl. Calculate the washbasin without accounting for the plateau and then add the cost of code XFP.

The width (w) is to be defined by you. The height (h) is 25mm and depth (d) is 270mm.

Plateau is calculated per piece, regardless of its width

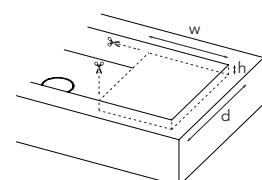

## 6. Brackets and ribs

### Side brackets

When defining the components for a wall-mounted Made to Measure washbasin, Not Only White provides white powder coated steel brackets (code **SB...**) to mount the washbasin to the wall. The rule of thumb is to support the washbasin top approx. every 600 - 800mm.

When installing the brackets, make sure they are positioned as shown in the diagram: thin side up.

We offer brackets for washbasins up to a maximum depth of 520mm in the following lengths:

SB270	bracket length 270mm
SB320	bracket length 320mm
SB370	bracket length 370mm
SB420	bracket length 420mm
SB470	bracket length 470mm

To decide which bracket length is needed, take 30mm off the washbasin depth. The first bracket option below this length is the bracket that will fit your washbasin perfectly.

**Brackets are calculated per set of two; it is possible to order per half a set**

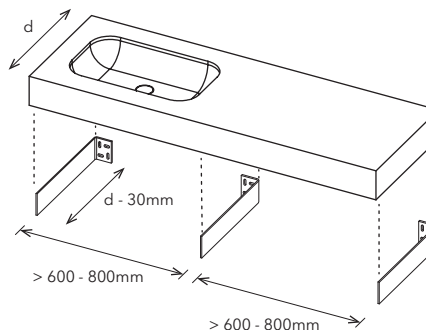

### Bowl bracket

In the case a bowl wider than 700mm is being used, we recommend to support the bowl with a white powder coated steel bowl bracket (code **BB...**).

This bowl bracket is additional to the side brackets.

BB330	bracket length 330mm
BB380	bracket length 380mm

To decide which bracket length is needed, take 30mm of the washbasin depth. The first bracket option below this length is the bracket that will fit your washbasin perfectly.

**Bowl brackets are calculated per piece**

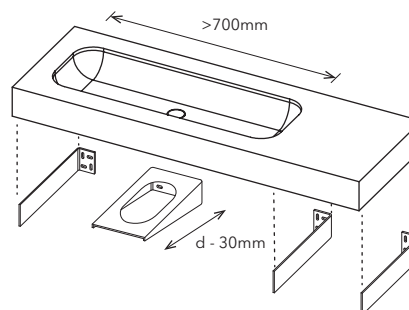

### Ribs

When defining the components for a Custom washbasin to be top-mounted on a cabinet or shelf, please take into consideration that ribs, made of plywood, will be needed to properly install the washbasin.

The ribs (code **RIB**) are also positioned underneath the top to strengthen the overall structure of the washbasin. For this purpose, a rib should be placed approx. every 600 - 800mm.

**Ribs are calculated per piece**

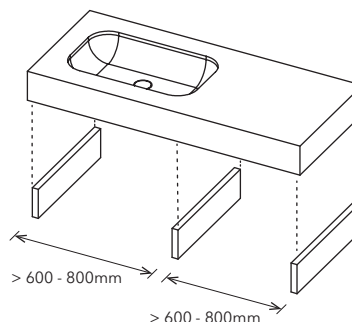



# Base



The Base collection consists of basic-shaped basins especially designed for the contract market. It is characterized by the 12mm radius inside the basin. This collection aims to be accessible, adaptable and easy to maintain.

Not only is Base perfect for the domestic environment, but its characteristics also make Base an ideal choice in hygienic surroundings and intensively-used restrooms, such as hospitals, exhibition centers or airports.

Design by Marike Andeweg

○ White Himacs



## Washbasin layout

Make a choice between a single or double bowl washbasin and fill in positions 1-5 or 1-6 accordingly.

Next step is to define the size of the bowl(s) indicated by the  - symbol. Go to page 24 and 25 for Base bowl sizes.

### SINGLE

-  bowl size
- ① max. 5000mm
- ② max. 550mm
- ③ min. 35mm
- ④ min. 30mm
- ⑤ min. 30mm  
min. 50mm with overflow  
min. 80mm with tap hole  
min. 120mm with tap hole + overflow

Note: when ordering only a top with bowl(s), sizes 3, 4 and 5 need to be adjusted according to the cabinet construction.

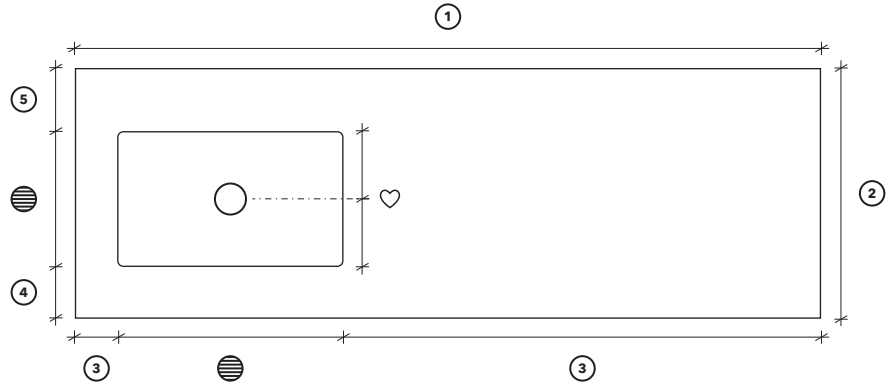

### DOUBLE

-  bowl size
- ① max. 5000mm
- ② max. 550mm
- ③ min. 35mm
- ④ min. 30mm
- ⑤ min. 30mm  
min. 50mm with overflow  
min. 80mm with tap hole  
min. 120mm with tap hole + overflow
- ⑥ min. 50mm

Note: when ordering only a top with bowl(s), sizes 3, 4 and 5 need to be adjusted according to the cabinet construction.

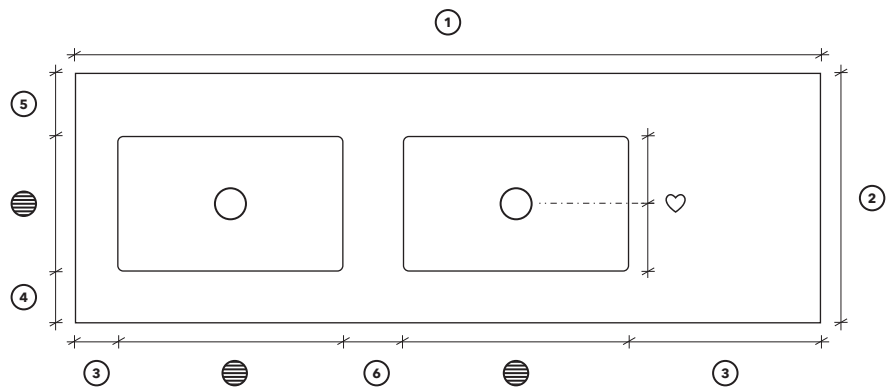

## Edge

Base washbasin can be supplied with a 12mm top or with an edge from 20mm up to 900mm. In order to conceal the bowl, Not Only White recommends an edge height as mentioned on pages 24 and 25 at the 'Bowls' section.

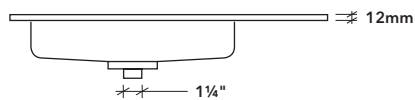

**H12**  
12mm top sheet

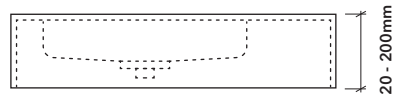

**EH100**  
Edge 20 - 100mm high

**EH150**  
Edge 101 - 150mm high

**EH200**  
Edge 151 - 200mm high

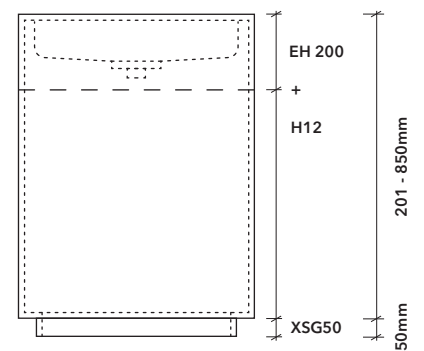

**EH200 + remaining m<sup>2</sup> in H12**  
Edge 201 - 850mm high

**XSG50**  
50mm plinth for floor-standing model

## Tap hole

If you need to fit a top-mounted tap, we can pre-drill the hole (code **HH35**).

Consider the space you would need to secure the tap with a tightening ring.

### Top-mounted tap without overflow:

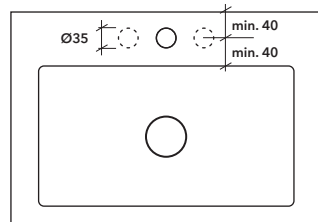

### Top-mounted tap with overflow:

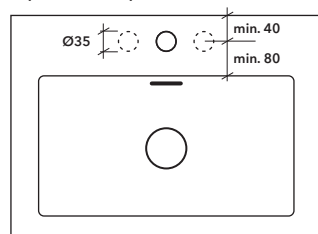

## Basq trays

Base washbasin can be supplied with a plateau on the side for Basq trays. Please refer to page 10 and 45.

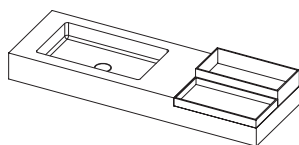

## Brackets and ribs

Please refer to page 11, where brackets and ribs are explained, to find out what type of support is needed for your washbasin.

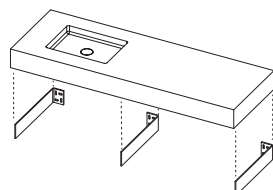

## Drain type

Depending on how the washbasin needs to look and work, you can choose from different drain types for Base.

### ① FLUSH DRAIN free flow drain

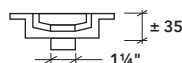

Base bowls are standard equipped with our Flush drain. This drain allows water to flow through at all times and cannot be closed.

**Flush drain is free of charge**

### ② POP-DOWN DRAIN closable drain

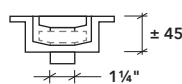

Our Pop-down drain has the same aesthetic as the Flush drain but it can be pressed down to close the drain.

**Pop-down drain is calculated per bowl**

For use with the Pop-down drain, Not Only White recommends to equip the bowl with an overflow.

### ③ DR72 DRAIN HOLE for a third party drain

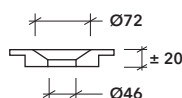

The DR72 drain hole is used for third party drains, both closable and non-closable.

**DR72 drain is free of charge**

Not Only White recommends to pair a third party closable drain with an overflow.

Note: when choosing a pop-down drain we recommend an overflow and extra edge height of 45mm. With a pop-down drain only we recommend an extra edge height of 15mm.

## Overflow

An overflow (code **OH50**) is used for bowls equipped with a closable drain.

The overflow drain tube needs 50mm at the back of the washbasin to fit.

The overflow ring, that drains excess water into the drain, adds 30mm of height underneath the basin drain.

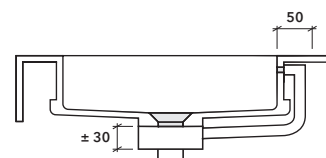

## Integrated backsplash

Not Only White offers an integrated backsplash on Base washbasins (code **CSP90H**) with a maximum height of 90mm.

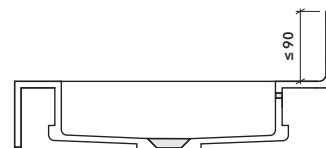

Note that a backsplash with a height over 90mm will be supplied as a separate piece without a radius edge.

**Separate backsplash is calculated per m<sup>2</sup>**



## Cut-outs and edge finishes

Please refer to page 10.

## Materials and colors

Himacs  White

## Bowls - 280mm

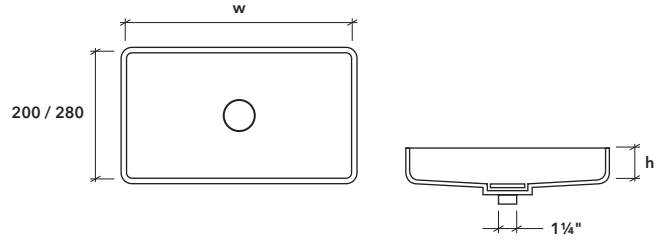

### w400mm x d280mm

**CBS40285**  
w400 x d280 x h50mm  
rec. edge height 90mm

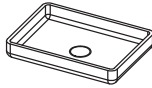

**CBS40287**  
w400 x d280 x h75mm  
rec. edge height 115mm

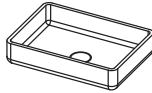

**CBS402810**  
w400 x d280 x h100mm  
rec. edge height 140mm

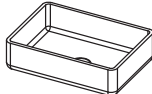

**CBS402815**  
w400 x d280 x h150mm  
rec. edge height 190mm

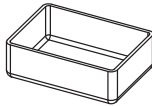

### w500mm x d280mm

**CBS50285**  
w500 x d280 x h50mm  
rec. edge height 95mm

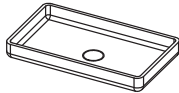

**CBS50287**  
w500 x d280 x h75mm  
rec. edge height 120mm

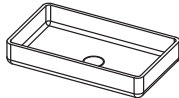

**CBS502810**  
w500 x d280 x h100mm  
rec. edge height 145mm

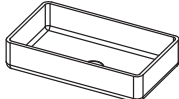

**CBS502815**  
w500 x d280 x h150mm  
rec. edge height 195mm

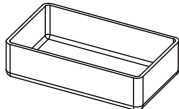

### w800mm x d280mm

**CBS80285**  
w800 x d280 x h50mm  
rec. edge height 100mm

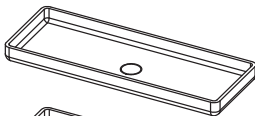

**CBS80287**  
w800 x d280 x h75mm  
rec. edge height 125mm



**CBS802810**  
w800 x d280 x h100mm  
rec. edge height 150mm



**CBS802815**  
w800 x d280 x h150mm  
rec. edge height 200mm

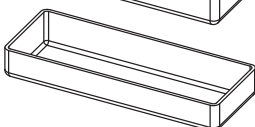

### w1000mm x d280mm

**CBS100285**  
w1000 x d280 x h50mm  
rec. edge height 100mm

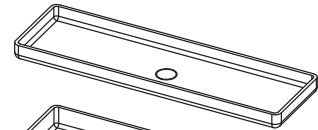

**CBS100287**  
w1000 x d280 x h75mm  
rec. edge height 125mm



**CBS1002810**  
w1000 x d280 x h100mm  
rec. edge height 150mm

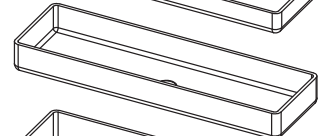

**CBS1002815**  
w1000 x d280 x h150mm  
rec. edge height 200mm

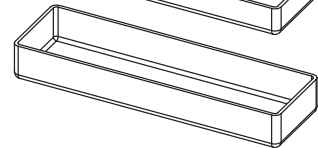

## For basin tops with short projection: Bowls with depth of only 200mm

### w300mm x d200mm

**CBS30205**  
w300 x d200 x h50mm  
rec. edge height 90mm

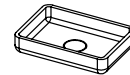

**CBS30207**  
w300 x d200 x h75mm  
rec. edge height 115mm

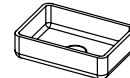

**CBS302010**  
w300 x d200 x h100mm  
rec. edge height 140mm

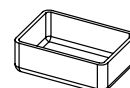

**CBS302015**  
w300 x d200 x h150mm  
rec. edge height 190mm

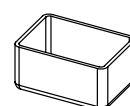

**Bowls - depth 300mm**

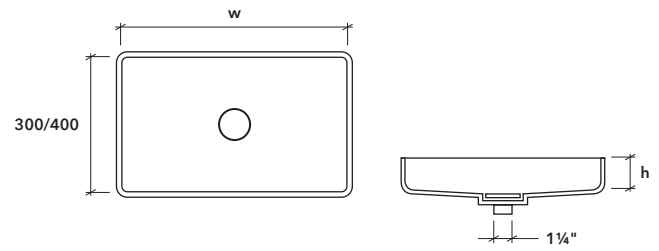

**w400mm x d300mm**

**CBS40305**

w400 x d300 x h50mm  
rec. edge height 90mm

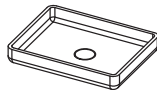

**CBS40307**

w400 x d300 x h75mm  
rec. edge height 115mm

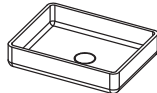

**CBS403010**

w400 x d300 x h100mm  
rec. edge height 140mm



**CBS403015**

w400 x d300 x h150mm  
rec. edge height 190mm

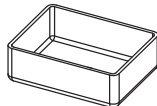

**w1000mm x d300mm**

**CBS100305**

w1000 x d300 x h50mm  
rec. edge height 100mm

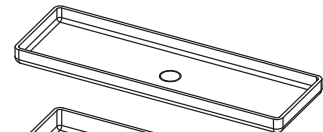

**CBS100307**

w1000 x d300 x h75mm  
rec. edge height 125mm

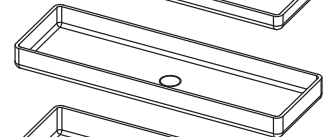

**CBS1003010**

w1000 x d300 x h100mm  
rec. edge height 150mm

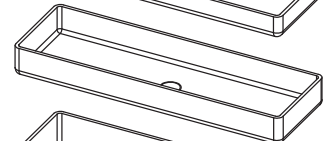

**CBS1003015**

w1000 x d300 x h150mm  
rec. edge height 200mm

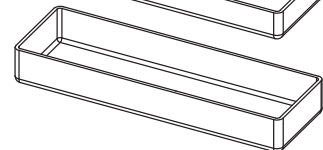

**w500mm x d300mm**

**CBS50305**

w500 x d300 x h50mm  
rec. edge height 95mm

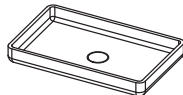

**CBS50307**

w500 x d300 x h75mm  
rec. edge height 120mm

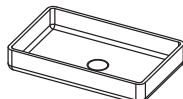

**CBS503010**

w500 x d300 x h100mm  
rec. edge height 145mm



**CBS503015**

w500 x d300 x h150mm  
rec. edge height 195mm

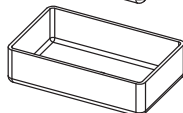

**w800mm x d300mm**

**CBS80305**

w800 x d300 x h50mm  
rec. edge height 100mm

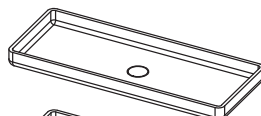

**CBS80307**

w800 x d300 x h75mm  
rec. edge height 125mm



**CBS803010**

w800 x d300 x h100mm  
rec. edge height 150mm



**CBS803015**

w800 x d300 x h150mm  
rec. edge height 200mm

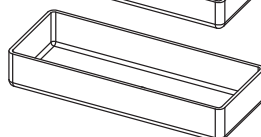

**w400/500/650mm x d400mm**

**CBS404010**

w400 x d400 x h100mm  
rec. edge height 140mm

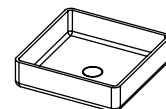

**CBS504010**

w500 x d400 x h100mm  
rec. edge height 145mm

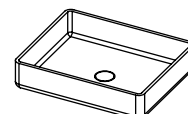

**CBS654010**

w650 x d400 x h100mm  
rec. edge height 150mm

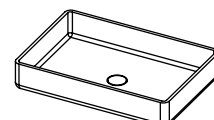

**For basin tops with a deep projection:  
Bowls with depth of 400mm**



# Blend



---

What makes the Blend collection so special is the fusion of the organic-shaped bowl with the linear top. The invisible design of the Flush drain fits the Blend perfectly. Blend invites you to touch it.



The curved design of the bowl allows for easy maintenance.

Design by Marike Andeweg



○ White Himacs



## Washbasin layout

Make a choice between a single or double bowl washbasin and fill in positions 1-5 or 1-6 accordingly.  
Next step is to define the size of the bowl(s) indicated by the  and  symbols. Go to page 31 for Blend bowl sizes.

### SINGLE

-  473 / 723 / 973mm
-  587 / 837 / 1087mm
- ① max. 5000mm
- ② max. 550mm
- ③ min. 30mm
- ④ min. 30mm
- ⑤ min. 30mm  
min. 75mm with tap hole

Note: when ordering only a top with bowl(s), sizes 3, 4 and 5 need to be adjusted according to the cabinet construction.

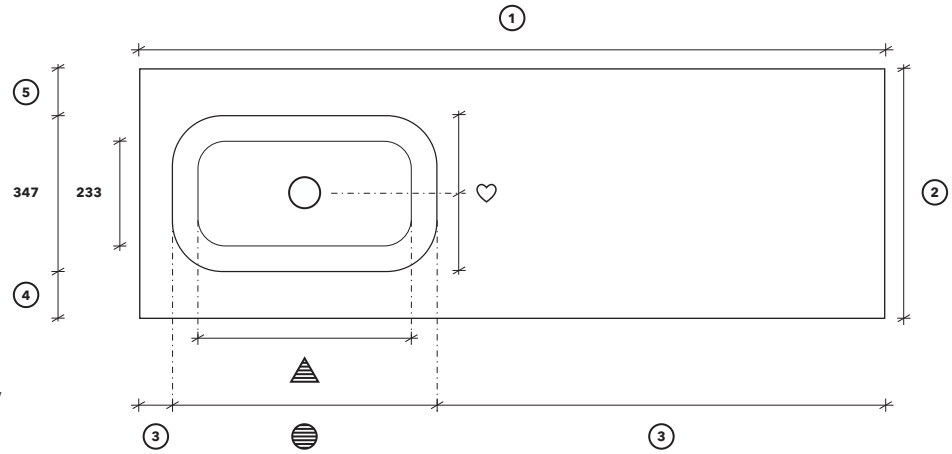

### DOUBLE

-  473 / 723 / 973mm
-  587 / 837 / 1087mm
- ① max. 5000mm
- ② max. 550mm
- ③ min. 30mm
- ④ min. 30mm
- ⑤ min. 30mm  
min. 75mm with tap hole
- ⑥ min. 60mm

Note: when ordering only a top with bowl(s), sizes 3, 4 and 5 need to be adjusted according to the cabinet construction.

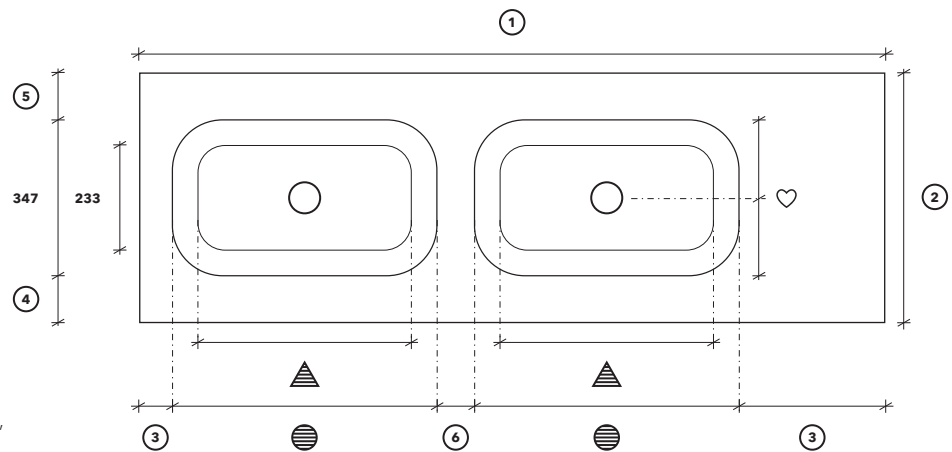

## Edge

Blend washbasin can be supplied with a 9mm top or with an edge from 20mm up to 900mm.

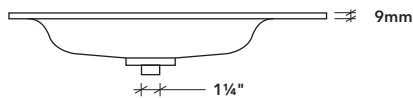

**H9**  
9mm top sheet

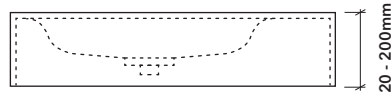

**EH100**  
Edge 20 - 100mm high

**EH150**  
Edge 101 - 150mm high

**EH200**  
Edge 151 - 200mm high

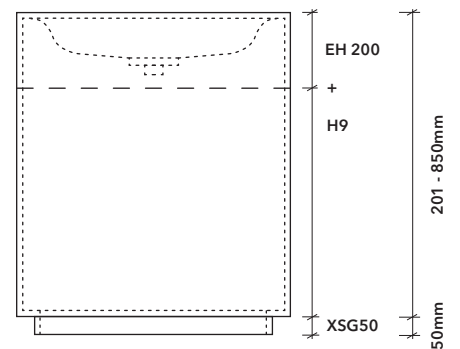

**EH200 + remaining m<sup>2</sup> in H9**  
Edge 201 - 850mm high

**XSG50**  
50mm plinth for floor-standing model

## Bowls

Blend bowls can only be ordered with at least a top.

### CBL47390

w587 x d347 x h90mm  
rec. edge height 125mm

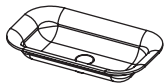

### CBL72390

w837 x d347 x h90mm  
rec. edge height 125mm

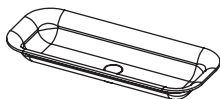

### CBL97390

w1087 x d347 x h90mm  
rec. edge height 130mm

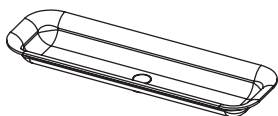

## Tap hole

If you need to fit a top-mounted tap, we can pre-drill the hole (code **HH35**).

Consider the space you would need to secure the tap with a tightening ring.

Top-mounted tap:

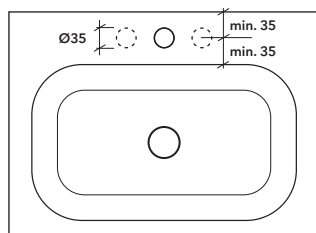

## Brackets and ribs

Please refer to page 11, where brackets and ribs are explained, to find out what type of support is needed for your washbasin.

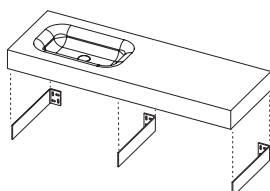

## Drain type

Depending on how the washbasin needs to look and work, you can choose from different drain types for Blend.

### 1 FLUSH DRAIN free flow drain

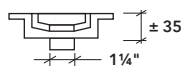

Blend bowls are standard equipped with our Flush drain. This drain allows water to flow through at all times and cannot be closed.

**Flush drain is free of charge**

### 2 POP-DOWN DRAIN closable drain

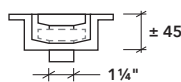

Our Pop-down drain has the same aesthetic as the Flush drain but it can be pressed down to close the drain.

**Pop-down drain is calculated per bowl**

For use with the Pop-down drain, Not Only White recommends to equip the bowl with an overflow.

### 3 DR72 DRAIN HOLE for a third party drain

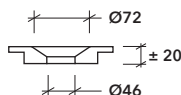

The DR72 drain hole is used for third party drains, both closable and non-closable.

**DR72 drain is free of charge**

Not Only White recommends to pair a third party closable drain with an overflow.

Note: when choosing a pop-down drain we recommend an extra edge height of 15mm.

## Overflow

An overflow is not possible.

## Integrated backsplash

Not Only White offers an integrated backsplash on Base washbasins (code **CSP90H**) with a maximum height of 90mm.

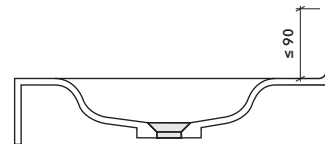

Note that a backsplash with a height over 90mm will be supplied as a separate piece without a radius edge.

**Separate backsplash is calculated per m<sup>2</sup>**

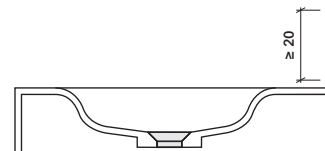

## Basq trays

Blend washbasin can be supplied with a plateau on the side for Basq trays. Please refer to page 10 and 45.

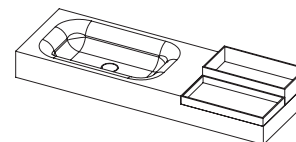

## Cut-outs and edge finishes

Please refer to page 10.

## Materials and colors

Himacs  White



# Box



---

Box collection is the answer to a tidy bathroom. Finally, everyday items like hairbrush and toothpaste have a home of their own. The Natural Oak tray from the Basq collection contrasts with the sleek white Himacs to give a surprising twist to the subtle design. Box is also available in Himacs only without the Basq tray.

Box is defined by a spacious rounded bowl, available in both single and double versions. The seamless round shape allows for easy maintenance.

Design by Marike Andeweg

White Himacs



## Washbasin layout

Make a choice between a single or double bowl washbasin and fill in positions 1-5 or 1-6 accordingly.  
Next step is to define the size of the bowl(s) indicated by the  - symbol. Go to page 37 for Box bowl sizes.

### SINGLE

-  576 / 1076mm
- ① max. 5000mm
- ② max. 550mm
- ③ min. 35mm
- ④ min. 32mm
- ⑤ min. 32mm  
min. 50mm with overflow  
min. 80mm with tap hole  
min. 120mm with tap hole + overflow

Note: when ordering only a top with bowl(s), sizes 3, 4 and 5 need to be adjusted according to the cabinet construction.

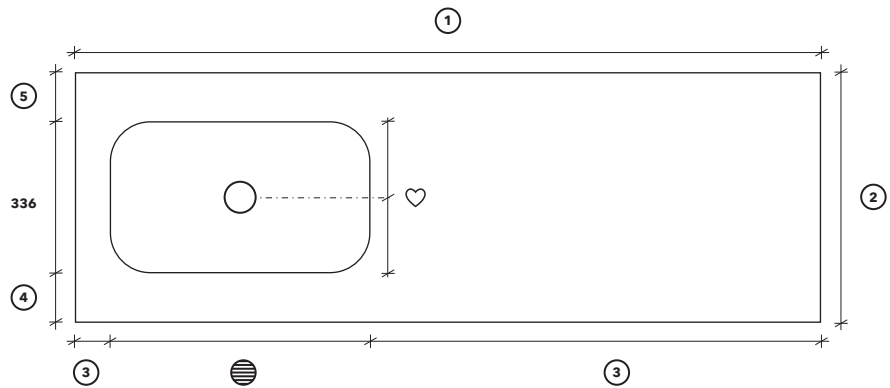

### DOUBLE

-  576 / 1076mm
- ① max. 5000mm
- ② max. 550mm
- ③ min. 35mm
- ④ min. 32mm
- ⑤ min. 32mm  
min. 50mm with overflow  
min. 80mm with tap hole  
min. 120mm with tap hole + overflow
- ⑥ min. 50mm

Note: when ordering only a top with bowl(s), sizes 3, 4 and 5 need to be adjusted according to the cabinet construction.

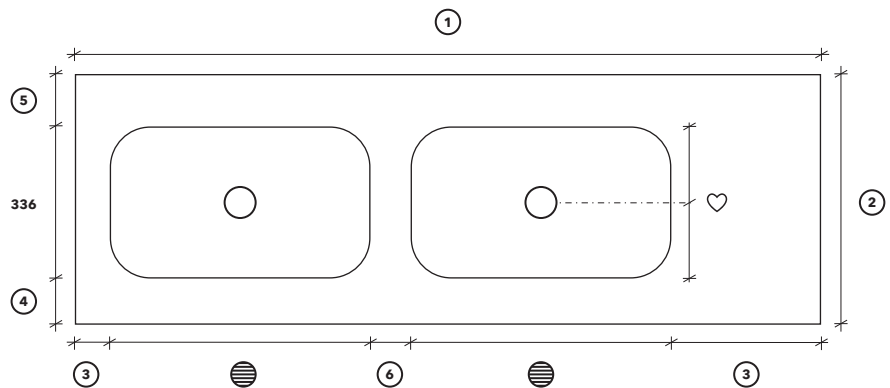

## Edge

Box washbasin can be supplied with a 12mm top or with an edge from 20mm up to 900mm.

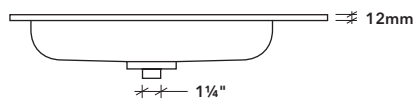

**H12**  
12mm top sheet

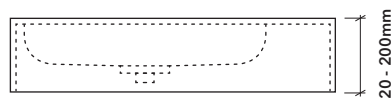

**EH100**  
Edge 20 - 100mm high

**EH150**  
Edge 101 - 150mm high

**EH200**  
Edge 151 - 200mm high

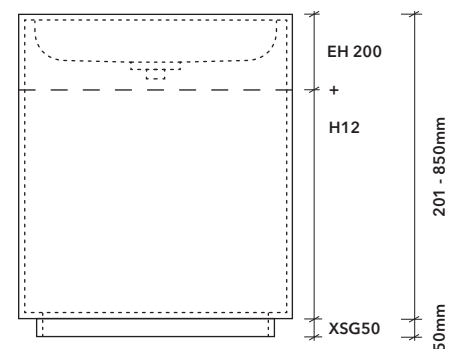

**EH200 + remaining m<sup>2</sup> in H12**  
Edge 201 - 850mm high

**XSG50**  
50mm plinth for floor-standing model

## Bowls

### CBX57688

w576 x d336 x h100mm  
rec. edge height 135mm

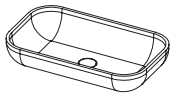

### CBX107688

w1076 x d336 x h100mm  
rec. edge height 145mm

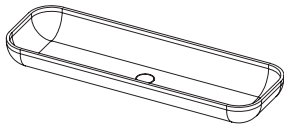

## Tap hole

If you need to fit a top-mounted tap, we can pre-drill the hole (code **HH35**).

Consider the space you would need to secure the tap with a tightening ring.

### Top-mounted tap without overflow:

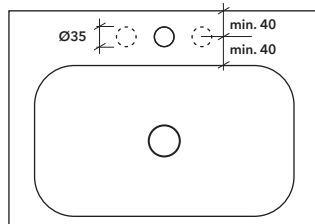

### Top-mounted tap with overflow:

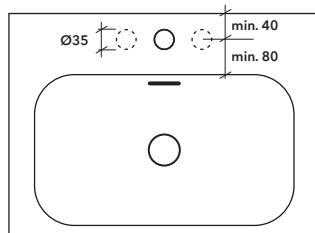

## Basq trays

Box washbasin can be supplied with a plateau on the side for Basq trays. Please refer to page 10 and 45.

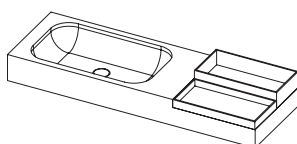

## Drain type

Depending on how the washbasin needs to look and work, you can choose from different drain types for Box.

### 1 FLUSH DRAIN free flow drain

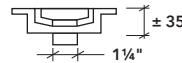

Box bowls are standard equipped with our Flush drain. This drain allows water to flow through at all times and cannot be closed.

**Flush drain is free of charge**

### 2 POP-DOWN DRAIN closable drain

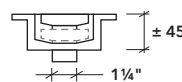

Our Pop-down drain has the same aesthetic as the Flush drain but it can be pressed down to close the drain.

**Pop-down drain is calculated per bowl**

For use with the Pop-down drain, Not Only White recommends to equip the bowl with an overflow.

### 3 DR72 DRAIN HOLE for a third party drain

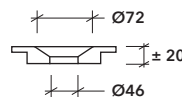

The DR72 drain hole is used for third party drains, both closable and non-closable.

**DR72 drain is free of charge**

Not Only White recommends to pair a third party closable drain with an overflow.

Note: when choosing a pop-down drain we recommend an overflow and extra edge height of 45mm. With a pop-down drain only we recommend an extra edge height of 15mm.

## Cut-outs and edge finishes

Please refer to page 10.

## Materials and colors

Himacs  White

## Brackets and ribs

Please refer to page 11, where brackets and ribs are explained, to find out what type of support is needed for your washbasin.

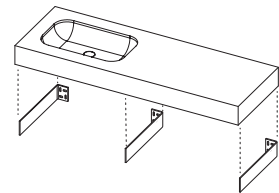

## Overflow

An overflow (code **OH50**) is used for bowls equipped with a closable drain.

The overflow drain tube needs 50mm at the back of the washbasin to fit.

The overflow ring, that drains excess water into the drain, adds 30mm of height underneath the basin drain.

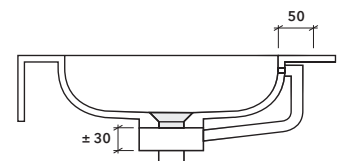

## Integrated backsplash

Not Only White offers an integrated backsplash on Base washbasins (code **CSP90H**) with a maximum height of 90mm.

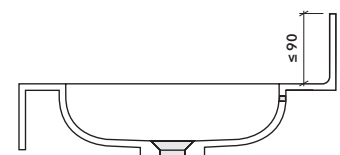

Note that a backsplash with a height over 90mm will be supplied as a separate piece without a radius edge.

**Separate backsplash is calculated per m<sup>2</sup>**

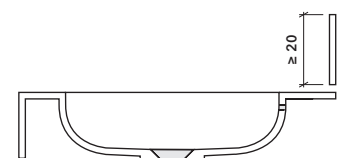



# Form



---

The Form's linearity gives the collection its signature clean and serene look. The rounded Flush drain, however, punctuates all the straight lines in a surprising and yet pleasing manner.

Next to the basin a lower plateau can be integrated to create a platform for a mounted tap or a space to place soap or other bathroom accessories.

Design by Marike Andeweg

○ White Himacs



## Washbasin layout

Make a choice between a single or double bowl washbasin and fill in positions 1-5 or 1-6 accordingly.

Next step is to define the size of the bowl(s) indicated by the  - symbol. Go to page 46 for Form bowl sizes.

### SINGLE

-  bowl width
- ① max. 5000mm
- ② max. 550mm
- ③ min. 35mm
- ④ min. 30mm
- ⑤ min. 30mm  
min. 50mm with overflow  
min. 80mm with tap hole  
min. 120mm with tap hole + overflow

Note: when ordering only a top with bowl(s), sizes 3, 4 and 5 need to be adjusted according to the cabinet construction.

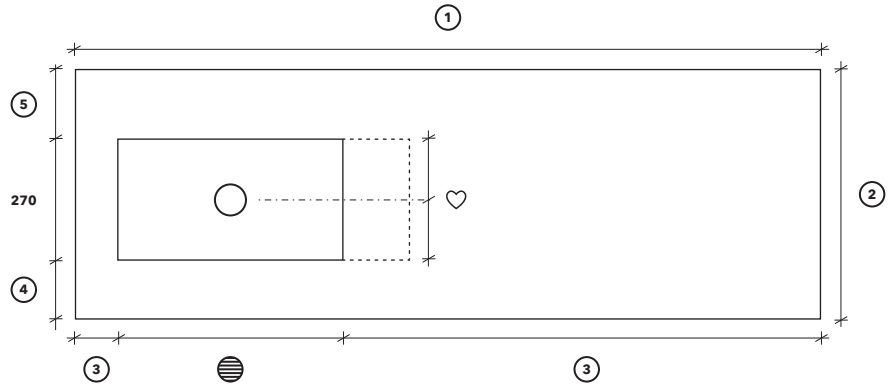

### DOUBLE

-  bowl width
- ① max. 5000mm
- ② max. 500mm
- ③ min. 35mm
- ④ min. 30mm
- ⑤ min. 30mm  
min. 50mm with overflow  
min. 80mm with tap hole  
min. 120mm with tap hole + overflow
- ⑥ min. 50mm

Note: when ordering only a top with bowl(s), sizes 3, 4 and 5 need to be adjusted according to the cabinet construction.

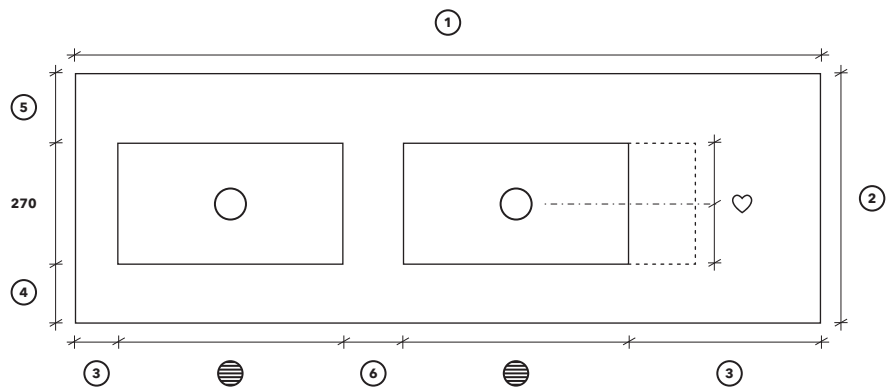

## Edge

Form washbasin can be supplied with a 12mm top or with an edge from 20mm up to 900mm. In order to conceal the bowl, Not Only White recommends an edge height as mentioned on page 46 at the 'Bowls' section.

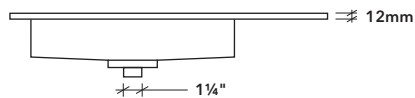

**H12**  
12mm top sheet

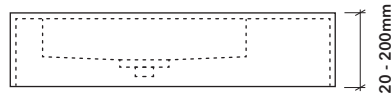

**EH100**  
Edge 20 - 100mm high

**EH150**  
Edge 101 - 150mm high

**EH200**  
Edge 151 - 200mm high

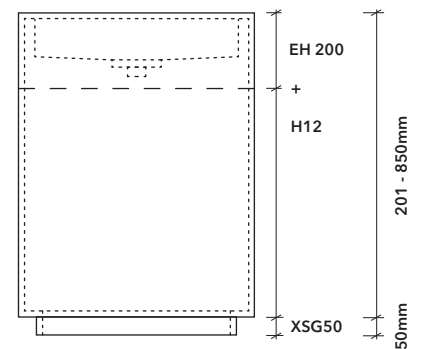

**EH200 + remaining m<sup>2</sup> in H12**  
Edge 201 - 850mm high

**XSG50**  
50mm plinth for floor-standing model

## Tap hole

If you need to fit a top-mounted tap, we can pre-drill the hole (code **HH35**).

Consider the space you would need to secure the tap with a tightening ring.

### Top-mounted tap without overflow:

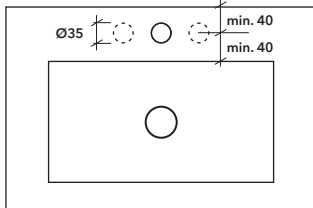

### Top-mounted tap with overflow:

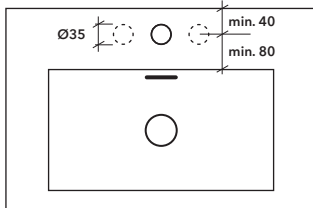

## Basq trays

Form washbasin can be supplied with a plateau on the side for Basq trays. Please refer to page 10 and 45.

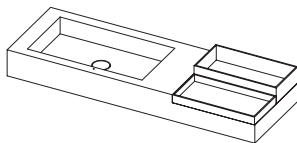

## Cut-outs and edge finishes

Please refer to page 10.

## Form plateau

Form can be delivered with a plateau next to right or the left side of the bowl. Please refer to page 10.

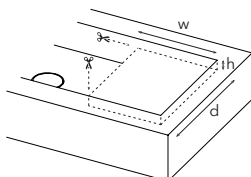

## Drain type

Depending on how the washbasin needs to look and work you can choose from different drain types for Form.

### 1 FLUSH DRAIN free flow drain

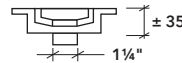

Form bowls are standard equipped with our Flush drain. This drain allows water to flow through at all times and cannot be closed.

Flush drain is free of charge

### 2 POP-DOWN DRAIN closable drain

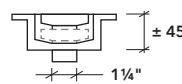

Our Pop-down drain has the same aesthetic as the Flush drain but it can be pressed down to close the drain.

Pop-down drain is calculated per bowl

For use with the Pop-down drain, Not Only White recommends to equip the bowl with an overflow.

### 3 DR72 DRAIN HOLE for a third party drain

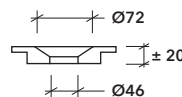

The DR72 drain hole is used for third party drains, both closable and non-closable.

DR72 drain is free of charge

Not Only White recommends to pair a third party closable drain with an overflow.

Note: when choosing a pop-down drain we recommend an overflow and extra edge height of 45mm. With a pop-down drain only we recommend an extra edge height of 15mm.

## Brackets and ribs

Please refer to page 11, where brackets and ribs are explained, to find out what type of support is needed for your washbasin.

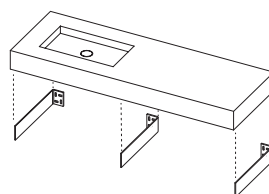

## Overflow

An overflow (code **OH50**) is used for bowls equipped with a closable drain.

The overflow drain tube needs 50mm at the back of the washbasin to fit.

The overflow ring, that drains excess water into the drain, adds 30mm of height underneath the basin drain.

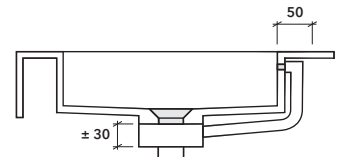

## Integrated backsplash

Not Only White offers an integrated backsplash on Form washbasins (code **CSP90H**) with a maximum height of 90mm.

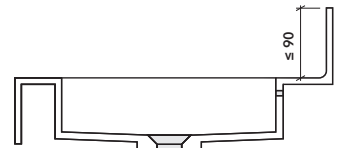

Note that a backsplash with a height over 90mm will be supplied as a separate piece without a radius edge.

Separate backsplash is calculated per m2

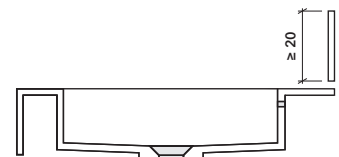

## Materials and colors

Himacs ○ White

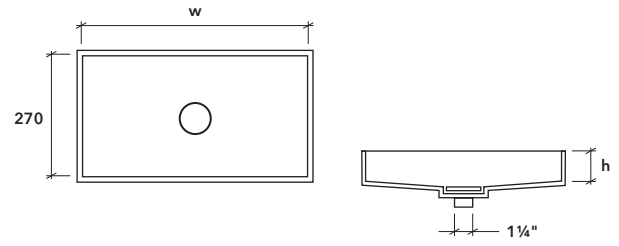

## Bowls - depth 270mm

Form bowls can only be ordered with at least a top

### w270mm

**CFM27050**

w270 x d270 x h50mm  
rec. edge height 90mm

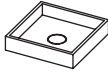

**CFM27075**

w270 x d270 x h75mm  
rec. edge height 115mm



**CFM270100**

w270 x d270 x h100mm  
rec. edge height 140mm



### w500mm

**CFM50050**

w500 x d270 x h50mm  
rec. edge height 95mm

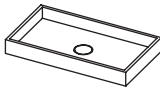

**CFM50075**

w500 x d270 x h75mm  
rec. edge height 120mm

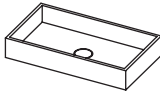

**CFM500100**

w500 x d270 x h100mm  
rec. edge height 145mm

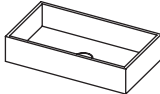

### w1000mm

**CFM100050**

w1000 x d270 x h100mm  
rec. edge height 95mm

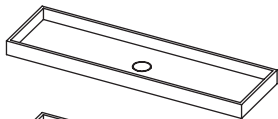

**CFM100075**

w1000 x d270 x h75mm  
rec. edge height 125mm

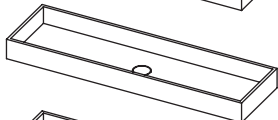

**CFM1000100**

w1000 x d270 x h100mm  
rec. edge height 150mm





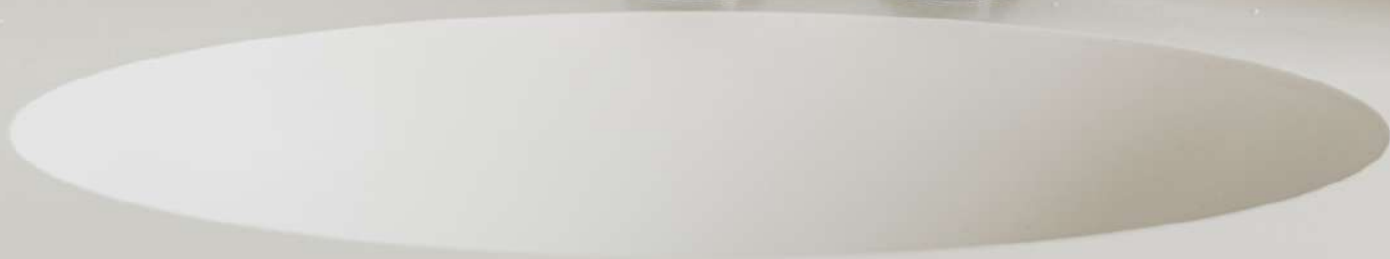

# Mono



---

The Mono collection arised from one beautifully oval shaped bowl. Its organic form draws you into the bowl, ready to freshen up. The linear top gives the Mono a timeless modern look and feel. This collection is suitable for many types of projects. It just feels right at home, in an office or a hotel.

Design by Marike Andeweg

○ White Himacs



## Washbasin layout

Make a choice between a single or double bowl washbasin and fill in positions 1-5 or 1-6 accordingly.

### SINGLE

- w450 x d300 mm
- ① max. 5000mm
- ② max. 550mm
- ③ min. 35mm
- ④ min. 30mm
- ⑤ min. 30mm  
min. 50mm with overflow  
min. 80mm with tap hole  
min. 120mm with tap hole + overflow

Note: when ordering only a top with bowl(s), sizes 3, 4 and 5 need to be adjusted according to the cabinet construction.

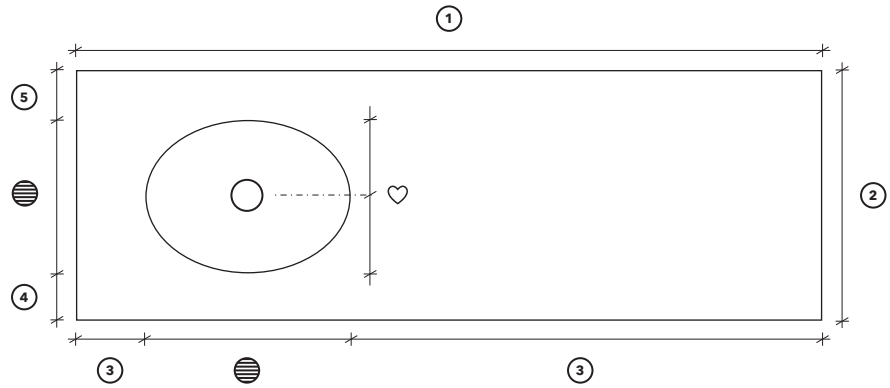

### DOUBLE

- w450 x d300 mm
- ① max. 5000mm
- ② max. 550mm
- ③ min. 35mm
- ④ min. 30mm
- ⑤ min. 30mm  
min. 50mm with overflow  
min. 80mm with tap hole  
min. 120mm with tap hole + overflow
- ⑥ min. 50mm

Note: when ordering only a top with bowl(s), sizes 3, 4 and 5 need to be adjusted according to the cabinet construction.

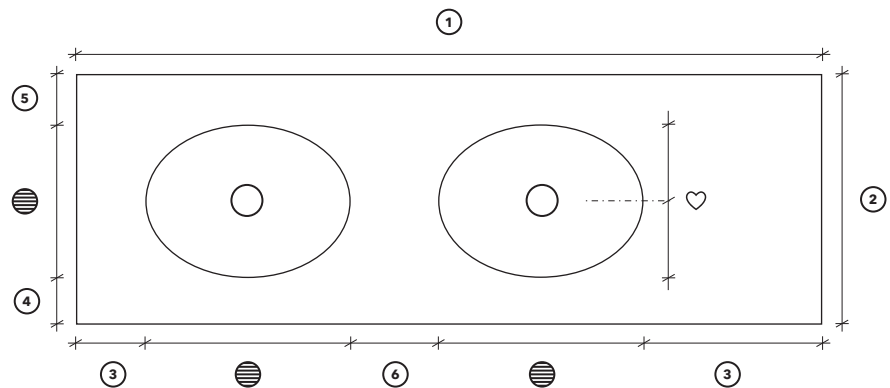

## Edge

Mono washbasin can be supplied with a 12mm top or with an edge from 20mm up to 900mm.

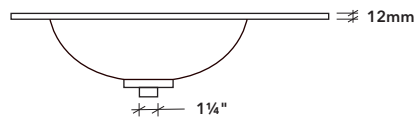

**H12**  
12mm top sheet

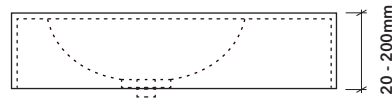

**EH100**  
Edge 20 - 100mm high

**EH150**  
Edge 101 - 150mm high

**EH200**  
Edge 151 - 200mm high

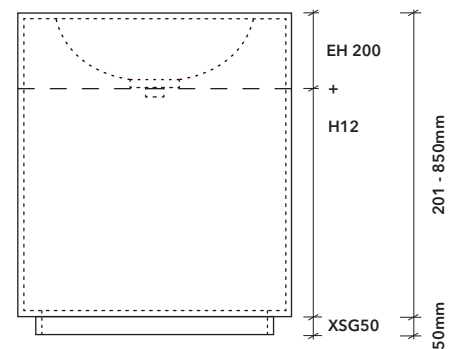

**EH200 + remaining m<sup>2</sup> in H12**  
Edge 201 - 850mm high

**XSG50**  
50mm plinth for floor-standing model

## Bowls

The Mono bowl can only be ordered with at least a top.

### CMO450

w450 x d300 x h120mm  
rec. edge height 135 mm



## Tap hole

If you need to fit a top-mounted tap, we can pre-drill the hole (code **HH35**).

Consider the space you would need to secure the tap with a tightening ring.

### Top-mounted tap without overflow:

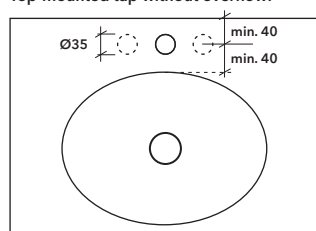

### Top-mounted tap with overflow:

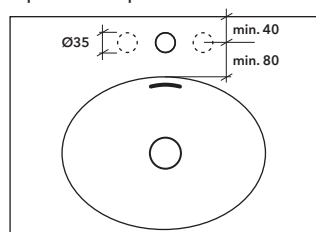

## Cut-outs and edge finishes

Please refer to page 10.

## Materials and colors

Himacs  White

## Drain type

Depending on how the washbasin needs to look and work, you can choose from different drain types for Mono.

### 1 FLUSH DRAIN free flow drain

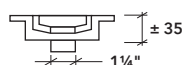

Mono bowls are standard equipped with our Flush drain. This drain allows water to flow through at all times and cannot be closed.

Flush drain is free of charge

### 2 POP-DOWN DRAIN closable drain

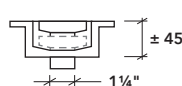

Our Pop-down drain has the same aesthetic as the Flush drain but it can be pressed down to close the drain.

Pop-down drain is calculated per bowl

For use with the Pop-down drain, Not Only White recommends to equip the bowl with an overflow.

### 3 DR72 DRAIN HOLE for a third party drain

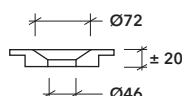

The DR72 drain hole is used for third party drains, both closable and non-closable.

DR72 drain is free of charge

Not Only White recommends to pair a third party closable drain with an overflow.

Note: when choosing a pop-down drain we recommend an overflow and extra edge height of 45mm. With a pop-down drain only we recommend an extra edge height of 15mm.

## Basq trays

Mono washbasin can be supplied with a plateau on the side for Basq trays. Please refer to page 10 and 45.

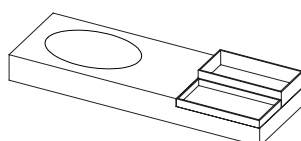

## Overflow

An overflow (code **OH50**) is used for bowls equipped with a closable drain.

The overflow drain tube needs 50mm at the back of the washbasin to fit.

The overflow ring, that drains excess water into the drain, adds 30mm of height underneath the basin drain.

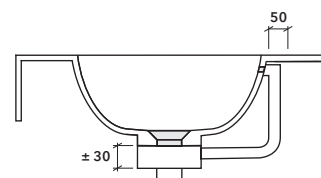

## Integrated backsplash

Not Only White offers an integrated backsplash on Base washbasins (code **CSP90H**) with a maximum height of 90mm.

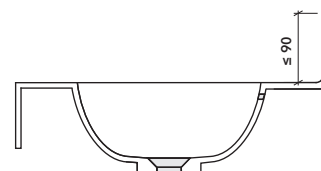

Note that a backsplash with a height over 90mm will be supplied as a separate piece without a radius edge.

Separate backsplash is calculated per m2

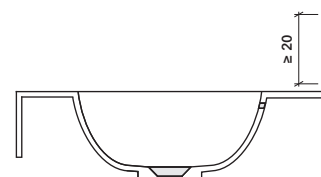

## Brackets and ribs

Please refer to page 11, where brackets and ribs are explained, to find out what type of support is needed for your washbasin.

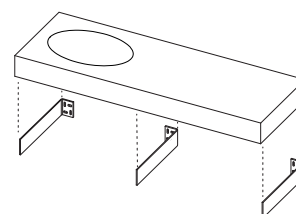



# Noon



The combination of the spacious round bowl and straight outlines of the top gives Noon its friendly and appealing appearance. Whether at home or in a luxurious hotel, using Noon washbasin is the perfect way to start or end your day.

Noon is a versatile collection which is reflected in the many options ranging from countertop bowls, undermounted and a handrinse collection.

Design by Marike Andeweg

○ White Himacs



## Washbasin layout

Make a choice between a single or double bowl washbasin and fill in positions 1-5 or 1-6 accordingly.

Next step is to define the size of the bowl(s) indicated by the  - symbol. Go to page 77 for Noon bowl sizes.

### SINGLE

-  340 / 400 / 460mm
- ① max. 5000mm
- ② max. 550mm
- ③ min. 35mm
- ④ min. 30mm
- ⑤ min. 30mm  
min. 50mm with overflow  
min. 80mm with tap hole  
min. 120mm with tap hole + overflow

Note: when ordering only a top with bowl(s), sizes 3, 4 and 5 need to be adjusted according to the cabinet construction.

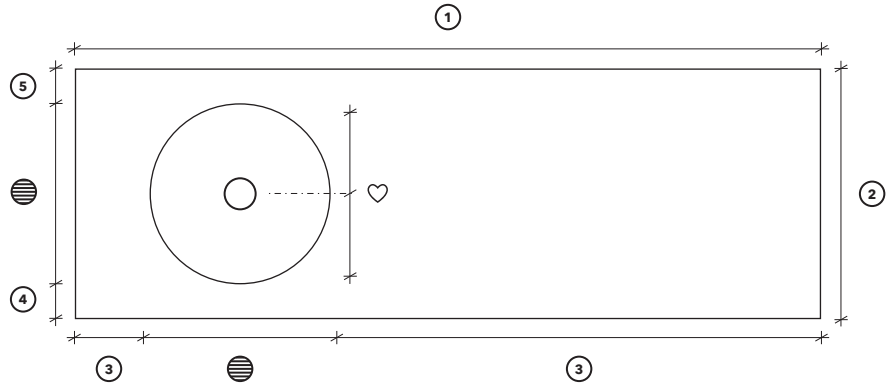

### DOUBLE

-  340 / 400 / 460mm
- ① max. 5000mm
- ② max. 550mm
- ③ min. 35mm
- ④ min. 30mm
- ⑤ min. 30mm  
min. 50mm with overflow  
min. 80mm with tap hole  
min. 120mm with tap hole + overflow
- ⑥ min. 50mm

Note: when ordering only a top with bowl(s), sizes 3, 4 and 5 need to be adjusted according to the cabinet construction.

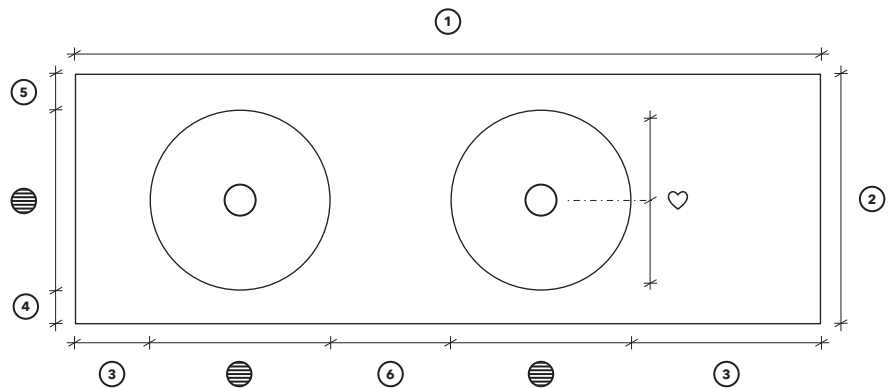

## Edge

Noon washbasin can be supplied with a 12mm top or with an edge from 20mm up to 900mm.

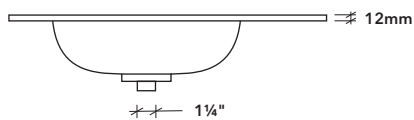

**H12**  
12mm top sheet

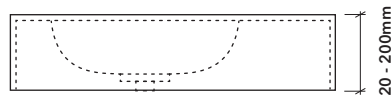

**EH100**  
Edge 20 - 100mm high

**EH150**  
Edge 101 - 150mm high

**EH200**  
Edge 151 - 200mm high

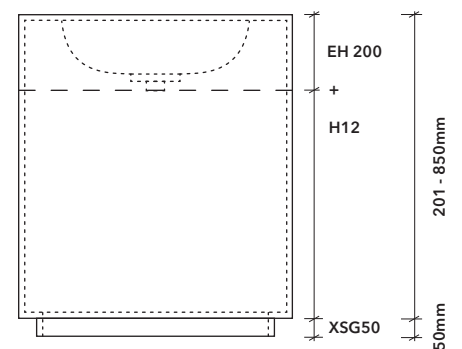

**EH200 + remaining m<sup>2</sup> in H12**  
Edge 201 - 850mm high

**XSG50**  
50mm plinth for floor-standing model

## Bowls

### CNN340

Ø340 x h114mm  
rec. edge height 150mm



### CNN400

Ø400 x h124mm  
rec. edge height 160mm



### CNN460

Ø460 x h134mm  
rec. edge height 170mm



## Tap hole

If you need to fit a top-mounted tap, we can pre-drill the hole (code **HH35**).

Consider the space you would need to secure the tap with a tightening ring.

### Top-mounted tap without overflow:

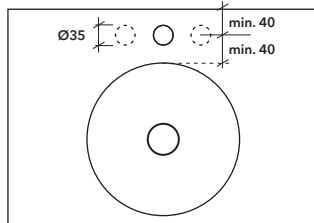

### Top-mounted tap with overflow:

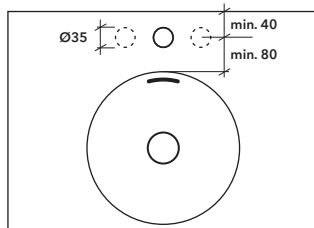

## Cut-outs and edge finishes

Please refer to page 10.

## Drain type

Depending on how the washbasin needs to look and work, you can choose from different drain types for Noon.

### 1 FLUSH DRAIN free flow drain

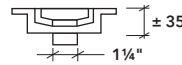

Noon bowls are standard equipped with our Flush drain. This drain allows water to flow through at all times and cannot be closed.

**Flush drain is free of charge**

### 2 POP-DOWN DRAIN closable drain

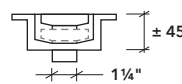

Our Pop-down drain has the same aesthetic as the Flush drain but it can be pressed down to close the drain.

**Pop-down drain is calculated per bowl**

For use with the Pop-down drain, Not Only White recommends to equip the bowl with an overflow.

### 3 DR72 DRAIN HOLE for a third party drain

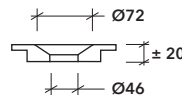

The DR72 drain hole is used for third party drains, both closable and non-closable.

**DR72 drain is free of charge**

Not Only White recommends to pair a third party closable drain with an overflow.

## Basq trays

Note: when choosing a pop-down drain we recommend an overflow and extra edge height of 45mm. With a pop-down drain only we recommend an extra edge height of 15mm.

## Basq trays

Noon washbasin can be supplied with a plateau on the side for Basq trays. Please refer to page 10 and 45.

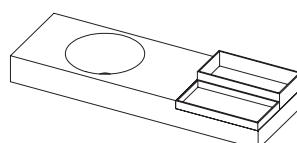

## Overflow

An overflow (code **OH50**) is used for bowls equipped with a closable drain.

The overflow drain tube needs 50mm at the back of the washbasin to fit.

The overflow ring, that drains excess water into the drain, adds 30mm of height underneath the basin drain.

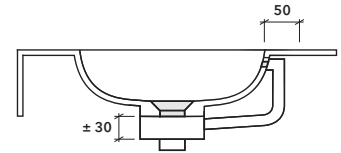

## Integrated backsplash

Not Only White offers an integrated backsplash on Base washbasins (code **CSP90H**) with a maximum height of 90mm.

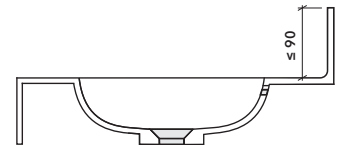

Note that a backsplash with a height over 90mm will be supplied as a separate piece without a radius edge.

**Separate backsplash is calculated per m2**

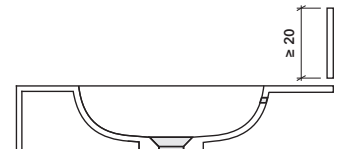

## Brackets and ribs

Please refer to page 11, where brackets and ribs are explained, to find out what type of support is needed for your washbasin.

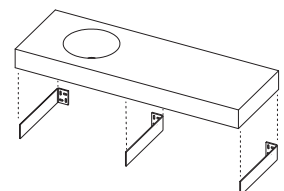

## Materials and colors

Himacs  White



# Unit cabinet



The Unit storage space is created to compliment all of our Himacs basins and Flat shelf by integrating much-welcomed extra storage space into the designs without compromising their simple aesthetics.

White Himacs

Unit is available as front, side, top and bottom storage space.

Design by Marike Andeweg



## Specifications

- seamlessly integrated
- including mounting hole(s)

### Side Unit

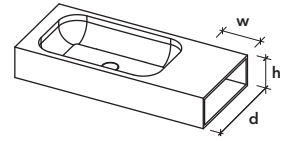
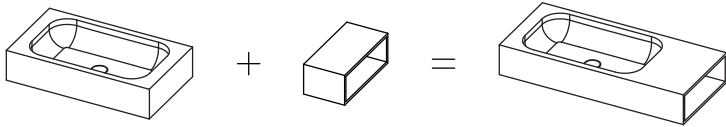

d140 - 260mm

d261 - 450mm

CSIU302630  
w100 - 300mm

w 100 - 300mm  
d 140 - 260mm  
h 150 - 300mm

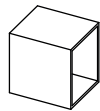

CSIU304530  
w100 - 300mm

w 100 - 300mm  
d 261 - 450mm  
h 150 - 300mm

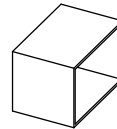

### Front Unit

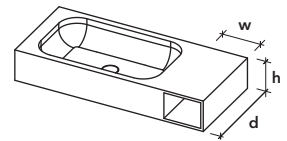
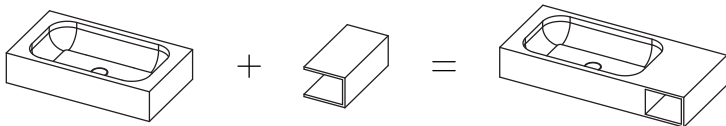

d140 - 260mm

d261 - 450mm

CFRU302630  
w100 - 300mm

w 100 - 300mm  
d 140 - 260mm  
h 150 - 300mm

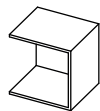

CFRU304530  
w100 - 300mm

w 100 - 300mm  
d 261 - 450mm  
h 150 - 300mm

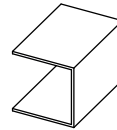

CFRU602630  
w301 - 600mm

w 301 - 600mm  
d 140 - 260mm  
h 150 - 300mm

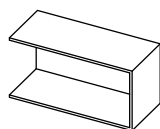

CFRU604530  
w301 - 600mm

w 301 - 600mm  
d 261 - 450mm  
h 150 - 300mm

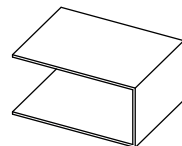

## Specifications

- seamlessly integrated
- including mounting hole(s) for bottom unit

### Top Unit

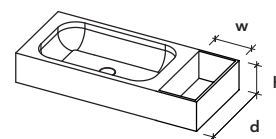
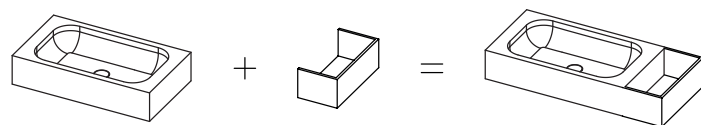

d140 - 260mm

d261 - 450mm

CTPU302630  
w300 - 700mm

w 100 - 300mm  
d 140 - 260mm  
h 150 - 300mm

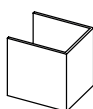

CTPU304530  
w300 - 700mm

w 100 - 300mm  
d 261 - 450mm  
h 150 - 300mm

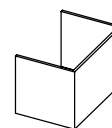

### Bottom Unit

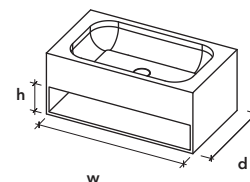
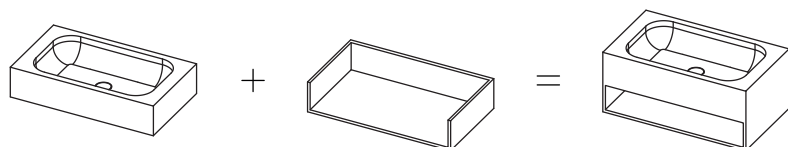

d140 - 260mm

d261 - 450mm

CBTU702630  
w300 - 700mm

w 300 - 700mm  
d 140 - 260mm  
h 150 - 300mm

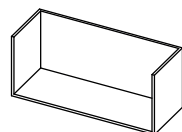

CBTU704530  
w300 - 700mm

w 300 - 700mm  
d 261 - 450mm  
h 150 - 300mm

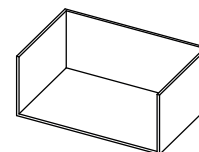

# Basq tray

Besides Natural Oak, Basq trays are also available in different Himacs colors.

Though a natural complement to the Box washbasin, the Basq trays can also be combined with all other Not Only White washbasins and Flat shelf in Himacs.

Design by Marike Andeweg



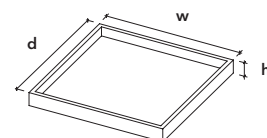

## Specifications

- Basq trays can be combined with Base, Blend, Box, Form, Kuub, Mono, Noon washbasins and Flat shelves with a lower side plateau by using code XPL

Himacs 12mm

Oak veneer 7mm

CBX20040  
w200 x d400 x h40mm

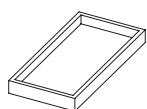

CBX20040-NO  
w200 x d400 x h40mm

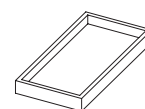

CBX20080  
w200 x d400 x h80mm

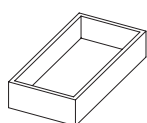

CBX20080-NO  
w200 x d400 x h80mm

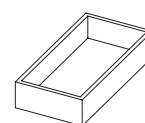

CBX40040  
w400 x d400 x h40mm

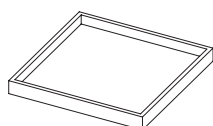

CBX40040-NO  
w400 x d400 x h40mm

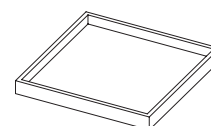

## Plateau for Basq tray

To create a plateau (code **XPL**) for the Basq tray, the edge on one or both sides of the washbasin can be lowered.

Calculate the washbasin without accounting for the plateau and then add the cost of code XPL.

The width (w) and height (h) are to be defined by you.

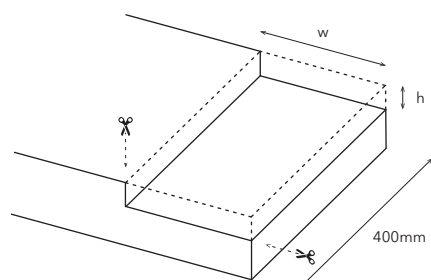

## Materials and colors

- Himacs**
- White
  - Grey
  - Concrete

- Oak veneer**
- Natural Oak

# Flat shelf

---

Flat shelves are an integral part of the Not Only White collection.

By using a customised shelf underneath or just next to your washbasin, you can easily create extra storage space. Ambiance can be personalized instantaneously by changing accessories placed on the shelf, such as towels and small storage boxes.

Design by Marike Andeweg



## Shelf layout

Fill in positions 1-2.

- ① max. 5000mm
- ② max. 550mm



## Edge

Flat shelf can be supplied with an edge from 20mm up to 900mm. In order to keep our brackets out of sight, Not Only White recommends an edge height of 85mm.

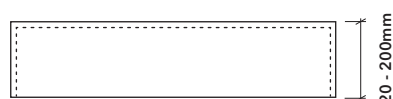

**EH100**  
Edge 20 - 100mm high

**EH150**  
Edge 101 - 150mm high

**EH200**  
Edge 151 - 200mm high

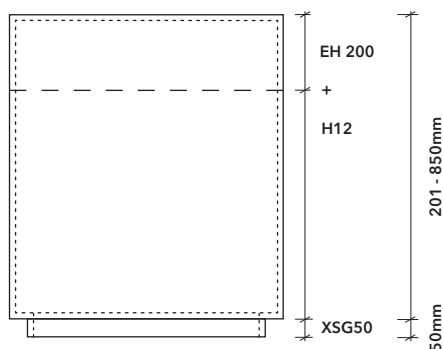

**EH200 + remaining m<sup>2</sup> in H12**  
Edge 201 - 850mm high

**XSG50**  
50mm plinth for floor-standing model

## Holes

In the case of a top-mounted tap, Not Only White can pre-drill tap holes (code **HH35**).

In the case of a countertop bowl, Not Only White can pre-drill a hole for the drain (code **HH70**).

In the case of a semi-recessed Noon bowl in Flat shelf, Not Only White can pre-mill a hole (code **HH170**).

## Brackets and ribs

Please refer to page 11, where brackets and ribs are explained, to find out what type of support is needed for your washbasin.

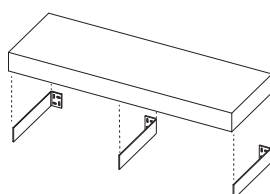

## Materials and colors

- Himacs**
- White
  - Grey

## Basq trays

Flat shelf can be supplied with a plateau on the side for Basq trays. Please refer to page 10 and 45.

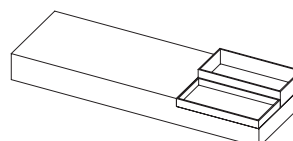



reddot award 2018  
winner

# Aim



---

Tasked with the brief of reinterpreting nostalgia in a contemporary context, Dutch designer Joost van der Vecht studied the characteristics of basin design throughout the last century, with the result being the Aim washbasin.

The essential edge detail on the outside anchors the sleekness of the overall look. The inside of the bowl is soft and rounded which is extended into detail in the almost invisible vaulting of the overflow. In order to accentuate the fluidity in the finer details, solid surface material Velluto® was chosen for Aim. The black Soft Touch coating creates tactility and interest to the base of the bowl, a design element which is often hidden.

Design by Joost van der Vecht

● White Velluto® biobased with black Soft Touch coating

## Specifications

- with closable click-clack waste kit with Velluto® drain cover and integrated overflow
- including Fischer bolt set for wall-mounting
- tap hole(s) have to be drilled by a professional installer
- with Soft Touch coating and towel rack in custom RAL color possible for projects from 20 pieces

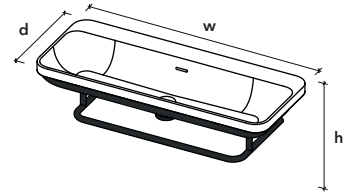

AIMST03-BL  
w1000 x d420 x h173mm  
Soft Touch coating RAL 9005

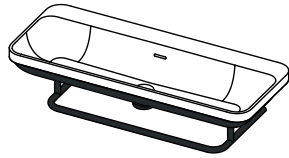

## Materials and colors

Velluto®  
biobased

- White with Soft Touch coating RAL 9005
- with Soft Touch coating in custom RAL color possible for projects from 20 pieces

Steel

- powder coating RAL 9005
- powder coating in custom RAL color possible for projects from 20 pieces

## Mounting

Side view

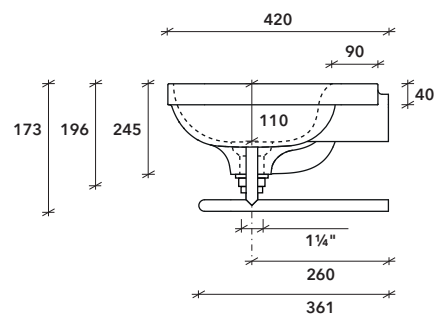

Back view

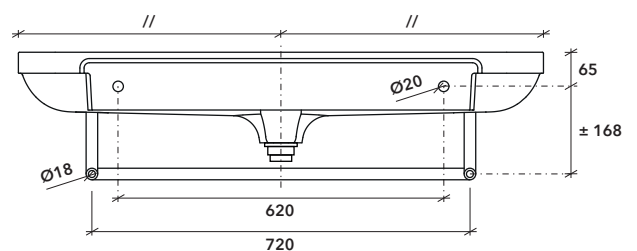



# Box countertop

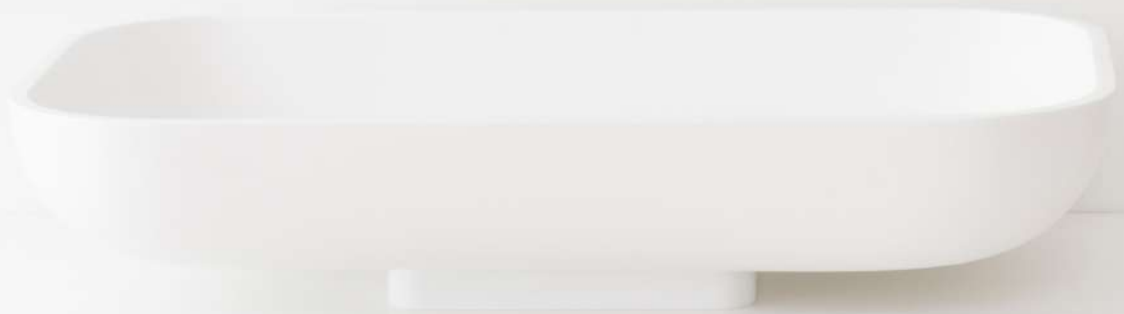

---

Box countertop bowl is defined by a spacious rounded shape, available in a single and double version. Maintenance is a breeze as the ancillary foot allows easy access to and around the base. Box is supplied with our Flush drain as standard.

Box can be combined with our Flat shelf or with a cabinet.

Design by Marike Andeweg

## Specifications

- delivered with our Flush drain
- Box countertop bowl should be fixed on top of a surface using flexible silicon

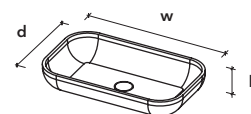

**FBXT01**  
w600 x d360 x h123mm  
12mm material thickness

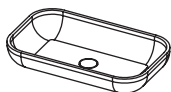

**FBXT03**  
w1100 x d360 x h123mm  
12mm material thickness

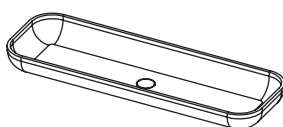

## Materials and colors

Himacs  White

## Drain type

Box countertop is delivered with matching free flow Himacs Flush drain. See drawing below.

The basin can also be equipped with our closable Pop-down drain.

### Front view

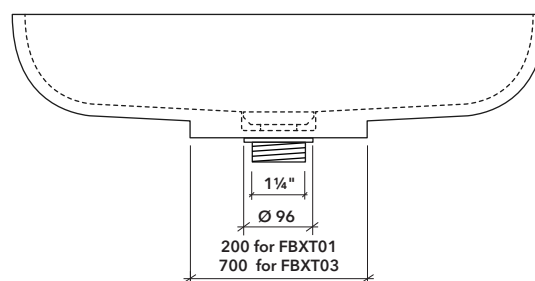

### Side view

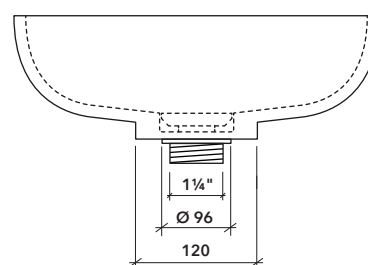



# Fall



---

Generous volumes in soft hues characterize Fall collection by designer Joost van der Vecht. A series of 3 countertop models, where the need for space determines the choice.

The concept is based on a play with height. Fall comes in a height of 180mm, 270mm and 360mm. The high Fall basin of 360mm will naturally be placed on a shelf closer to the floor which results in a nifty volume next to basin for accessories.

Fall has a soft minimalist appearance due to its straight lines combined with the smooth color tints of Himacs like Sea Oat Quartz, Peanut Butter and White Quartz.

Design by Joost van der Vecht

- White Himacs
- White Quartz Himacs
- Sea Oat Quartz Himacs
- Peanut Butter Himacs

## Specifications

- with 5mm slot drain
- removable inlay for cleaning
- countertop model
- delivered in White, White Quartz, Sea Oat Quartz and Peanut Butter Himacs

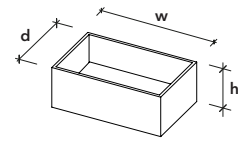

w480mm

**FFA01**  
w480 x d300 x h180mm  
inlay 120mm down from top

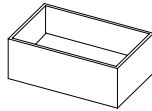

**FFA02**  
w480 x d300 x h270mm  
inlay 180mm down from top

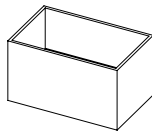

**FFA03**  
w480 x d300 x h360mm  
inlay 240mm down from top

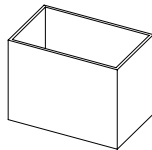

## Materials and colors

### Himacs



White



Sea Oat Quartz



White Quartz



Peanut Butter





# Frame



The open structure of the Frame collection literally frames and reveals the shape of the basin above. This partnership is best expressed when paired with the Blend whereby the straight line of the metal Frame is contrasted with the sinuous underside of the basin.

The Frame offers sufficient storage space yet at the same time stays transparent and unobtrusive. The shelf is made of 9mm Himacs.

Design by Marike Andeweg

- White Himacs
- White powder coated steel

# Frame

## Frame Models

### Specifications

- delivered with our Flush drain
- delivered including white powder coated steel frame and white Himacs bottom shelf
- the position of the bowl can be changed on demand
- Any RAL color possible for the frame for projects from 20 pieces

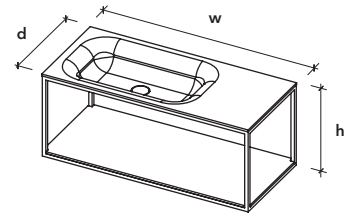

**FFRB02**  
w900 x d400 x h370mm  
bowl w473 x d233 x h90mm

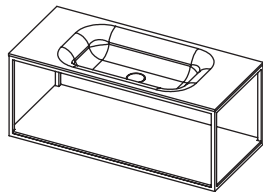

**FFRB08**  
w1150 x d400 x h370mm  
bowl w473 x d233 x h90mm

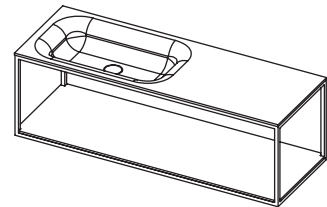

**FFRB03**  
w1150 x d400 x h370mm  
bowl w473 x d233 x h90mm

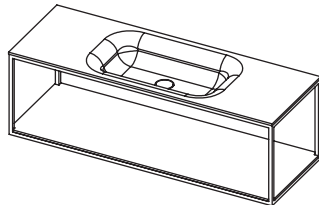

**FFRB10**  
w900 x d400 x h370mm  
bowl w473 x d233 x h90mm

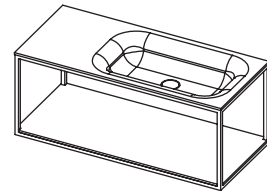

**FFRB04**  
w1150 x d400 x h370mm  
bowl w973 x d233 x h90mm

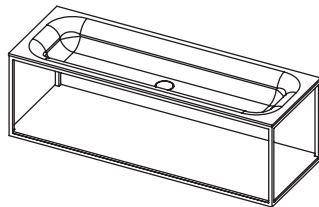

**FFRB11**  
w1150 x d400 x h370mm  
bowl w473 x d233 x h90mm

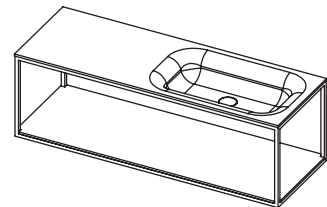

**FFRB07**  
w900 x d400 x h370mm  
bowl w473 x d233 x h90mm

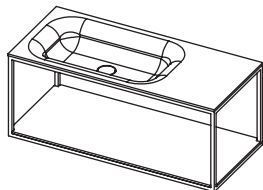

**FFRB13**  
w1150 x d400 x h370mm  
bowl w723 x d233 x h90mm

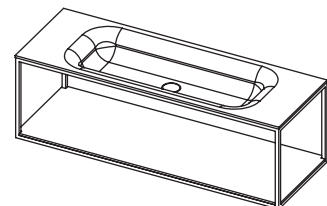





# Fuse



The distinctive character of the Fuse is the amalgamation of straight and curved lines. The organic-shaped basin with the subtle but sinuous integrated overflow on the inside is punctuated by the straight lines on the outside. The back edge where Fuse is mounted on the wall is set lower to create a floating effect and shelf space at the same time. The bottle trap is almost concealed underneath the basin to make the Fuse an object.

Fuse is available in white Velluto® biobased and with a dark blue and silk grey Soft Touch coating on the outside.

Design by Marike Andeweg

- White Velluto® biobased
- Dark Blue Soft Touch coating
- Silk Grey Soft Touch coating



reddot award 2015  
winner

## Specifications

- delivered with closable click-clack waste kit with Velluto® drain cover and integrated overflow
- including Fischer bolt set for wall-mounting
- including Senzo siphon (also possible to use a siphon of your own choice)
- optional: Palette finish in NCS or RAL color for projects from 10 pieces
- optional: Soft Touch coating in NCS or RAL color for projects from 10 pieces

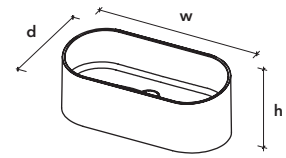

FSE02  
w700 x d400 x h270mm  
white



FSEST02-5008  
w700 x d400 x h270mm  
Dark Blue Soft Touch coating

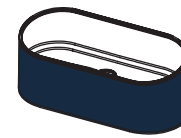

FSEST02-7044  
w700 x d400 x h270mm  
Silk Grey Soft Touch coating

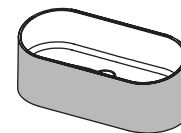

## Materials and colors

Velluto®  
biobased

- White
- with Dark Blue Soft Touch coating (RAL 5008)
- with Silk Grey Soft Touch coating (RAL 7044)
- with Soft Touch coating in custom NCS or RAL color possible for projects from 10 pieces
- with Palette finish in custom NCS or RAL color possible for projects from 10 pieces

## Mounting

Side view

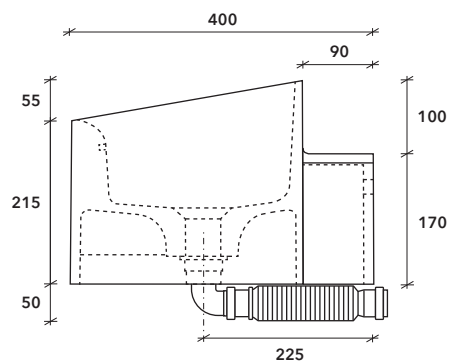

Back view

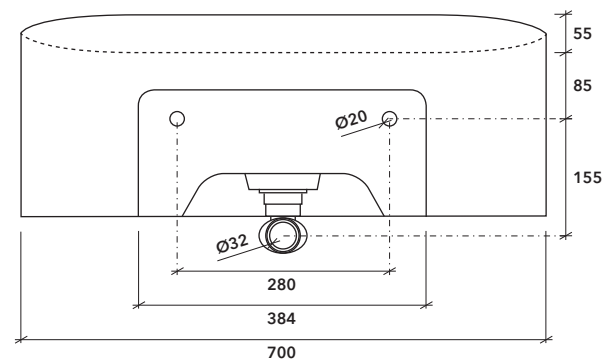





# Nest



---

Nest is an elegant, slim-edged countertop washbasin made of white Velluto® biobased. The collection offers a round, square and rectangular model. The round model is also standard available with a silk grey Soft Touch coating.

Depending on the styling of the overall setting, Nest can create a simple and pure feeling. Yet by introducing elements like a marble shelf and copper tapware, Nest can achieve the ultimate classical and luxurious look.

Nest collection is perfectly suitable for residential as well as commercial projects. Especially with our Palette finish and haptic Soft Touch coating unique designs can be created that suit your bathroom design.

- White Velluto® biobased
- with Palette finish
- with Soft Touch coating
- Silk Grey Soft Touch coating

## Specifications

- including free flow waste kit with Velluto® drain cover
- countertop model
- optional: Palette finish in custom NCS or RAL color
- optional: Soft Touch coating in custom NCS or RAL color

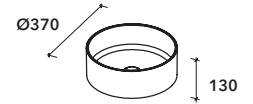

Ø370mm

**NST370**  
Ø370 x h130mm  
white

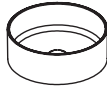

**NST370-PNCS / NST370-PRAL**  
Ø370 x h130mm  
Palette finish - custom color

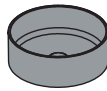

**NST370-SNCS / NEST370-SRAL**  
Ø370 x h130mm  
Soft Touch coating - custom color



**NST370-SSGREY**  
Ø370 x h130mm  
Silk Grey Soft Touch coating

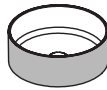

## Materials and colors

**Velluto®  
biobased**

- White
- with Soft Touch coating Silk Grey (RAL 7044)
- with Palette finish in custom NCS or RAL color possible
- with Soft Touch coating in custom NCS or RAL color possible

## Drain type

Nest is delivered with matching free flow Velluto® drain cover. See drawing below.

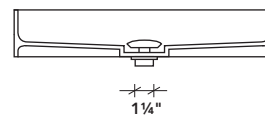

## Specifications

- including free flow waste kit with Velluto® drain cover
- countertop model
- optional: Palette finish in custom NCS or RAL color
- optional: Soft Touch coating in custom NCS or RAL color

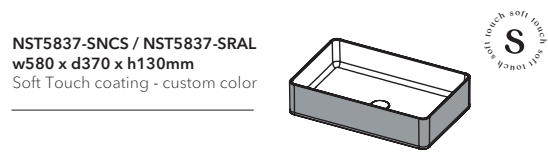
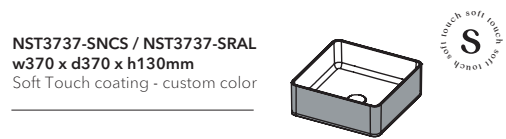
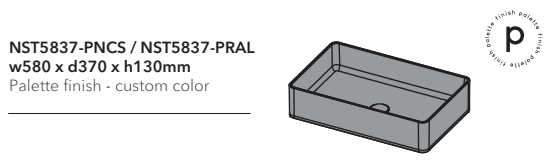
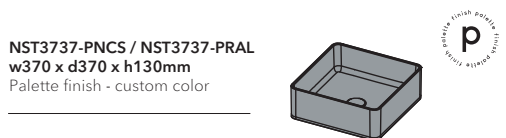
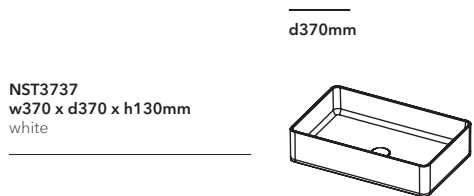
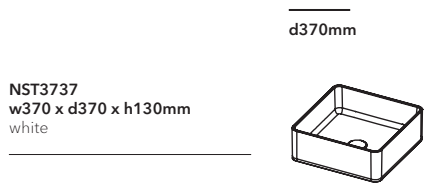
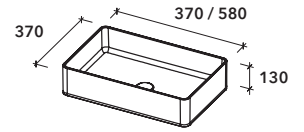

## Materials and colors

Velluto®  
biobased

- White
- with Palette finish in custom NCS or RAL color possible
- with Soft Touch coating in custom NCS or RAL color possible

## Drain type

Nest is delivered with matching free flow Velluto® drain cover. See drawing below.

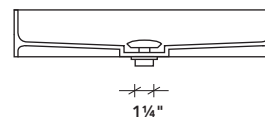

# Noon countertop



---

Noon countertop is a friendly and bowl-shaped basin made out of Himacs that can be placed on top of our Flat shelf or a cabinet from a third party. The foot elevates the Noon from the surface, allowing for easy maintenance and adding an extra dimension to its appearance.

Design by Marike Andeweg

## Specifications

- delivered with our Flush drain
- Noon countertop bowl should be fixed on top of a surface using flexible silicon



**FNN364**  
**Ø364 x h150mm**  
 inside Ø340 x h114mm



**FNN424**  
**Ø424 x h160mm**  
 inside Ø400 x h124mm



**FNN484**  
**Ø484 x h170mm**  
 inside Ø460 x h134mm



## Materials and colors

Himacs

White

## Drain type

Noon countertop is delivered with matching free flow Himacs drain. See drawing below.

The basin can also be equipped with our closable Pop-down drain.

Front / side view

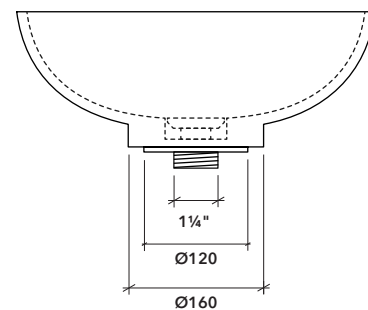



# Pose



---

Pose collection is a serie of round and square pilars. The matte white columns have a thin edge of 10mm and are made of the high quality solid surface material Velluto® biobased.

Because of its noble appearance, Pose collection can effortlessly be used in many styles. Be it at home or in a commercial environment. To give it an individual signature, the complete product can be colored with our Palette finish. Or emphasize only the outside of Pose with our tactile Soft Touch coating.

Creating a luxurious, modest bathroom has never been this easy.

- White Velluto® biobased
- with Palette finish
- with Soft Touch coating

# Pose

Pose Models

## Specifications

- including click-clack waste kit with Velluto® drain cover
- floor-standing model
- with siphon opening in back
- optional: Palette finish in custom NCS or RAL color
- optional: Soft Touch coating in custom NCS or RAL color

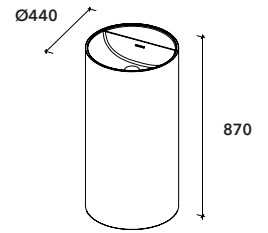

no tap hole

with tap hole

POS10  
Ø440 x h870mm  
white

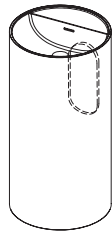

POS12  
Ø440 x h870mm  
white  
with tap hole Ø35mm

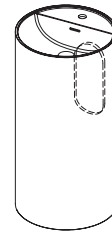

POS10-PNCS / POS10-PRAL  
Ø440 x h870mm  
Palette finish - custom color

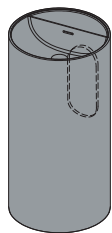

POS12-PNCS / POS12-PRAL  
Ø440 x h870mm  
Palette finish - custom color  
with tap hole Ø35mm



POS10-SNCS / POS10-SRAL  
Ø440 x h870mm  
Soft Touch coating - custom color

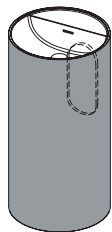

POS12-SNCS / POS12-SRAL  
Ø440 x h870mm  
Soft Touch coating - custom color  
with tap hole Ø35mm



## Materials and colors

Velluto®  
biobased

- White
- with Palette finish in custom NCS or RAL color possible
- with Soft Touch coating in custom NCS or RAL color possible

## Drain type

Pose is delivered with matching Velluto® drain cover.  
See drawing below.

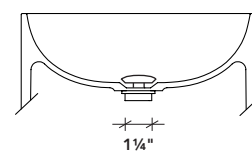

## Specifications

- including click-clack waste kit with Velluto® drain cover
- floor-standing model
- with siphon opening in back
- optional: Palette finish in custom NCS or RAL color
- optional: Soft Touch coating in custom NCS or RAL color

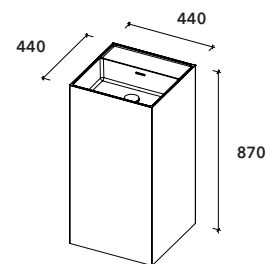

no tap hole

**POS20**  
w440 x d440 x h870mm  
white

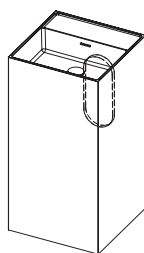

with tap hole

**POS22**  
w440 x d440 x h870mm  
white  
with tap hole Ø35mm

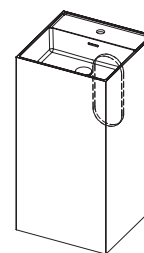

**POS20-PNCS / POS20-PRAL**  
w440 x d440 x h870mm  
Palette finish - custom color

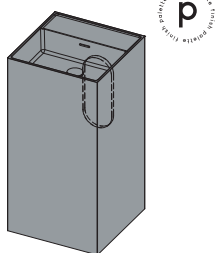

**POS22-PNCS / POS22-PRAL**  
w440 x d440 x h870mm  
Palette finish - custom color  
with tap hole Ø35mm

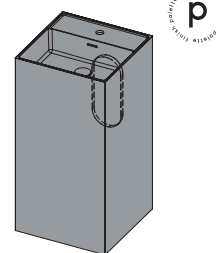

**POS20-SNCS / POS20-SRAL**  
w440 x d440 x h870mm  
Soft Touch coating - custom color

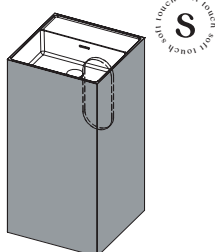

**POS22-SNCS / POS22-SRAL**  
w440 x d440 x h870mm  
Soft Touch coating - custom color  
with tap hole Ø35mm

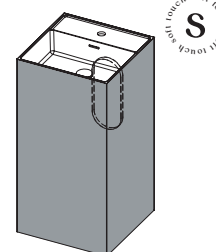

## Materials and colors

**Velluto®  
biobased**

- White
- with Palette finish in custom NCS or RAL color possible
- with Soft Touch coating in custom NCS or RAL color possible

## Drain type

Pose is delivered with matching Velluto® drain cover.  
See drawing below.

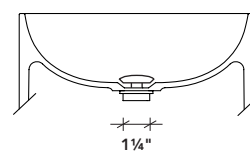



# Scape



---

Scape collection consists of a series of black and white floor-standing Models. Carefully chosen ratios and the right mix of color and material make Scape an intriguing object. The collection takes its name from 'landscapes' in which the various inlays create different sceneries by its interaction with the Himacs monolith.

Design by Joost van der Vecht

- Black Himacs
- White Himacs
- Neolith Blanco Carrara

# Scape

## Specifications

- delivered in Black or White Himacs
- floor-standing with adjustable feet
- delivered with access hatch

## Scape Models

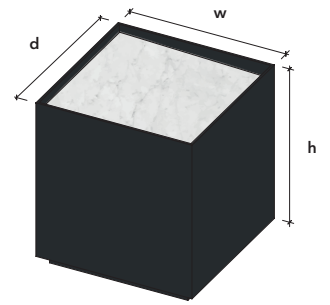

**FSC01**  
w840 x d840 x h900mm  
with white Himacs blocks interior

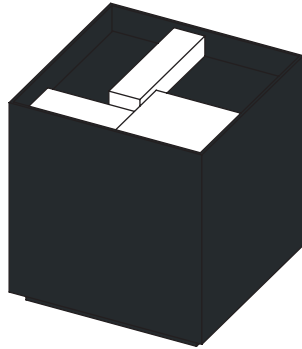

**FSC05**  
w840 x d840 x h900mm  
with white Himacs blocks interior

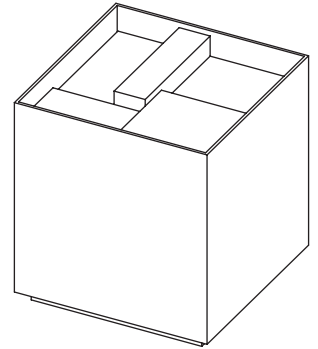

**FSC03**  
w840 x d840 x h900mm  
with Neolith Blanco Carrara interior

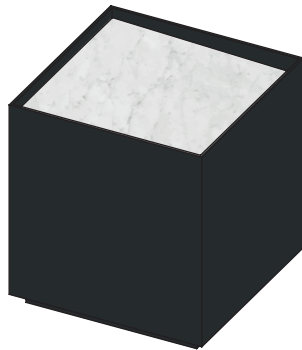

**FSC07**  
w840 x d840 x h900mm  
with Neolith Blanco Carrara interior

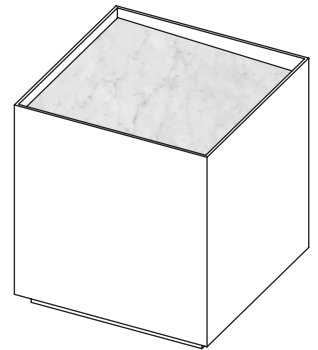

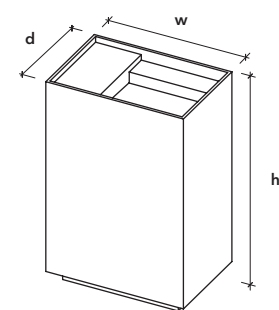

## Specifications

- floor-standing with adjustable feet
- with integrated cabinet with access hatch
- to be placed against wall (back side is open)
- necessary tap hole(s) to be ordered separately by using code HH35

**FSC20**  
w600 x d400 x h900mm  
bowl width 376mm

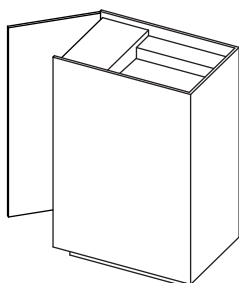

**FSC30**  
w600 x d400 x h900mm  
bowl width 376mm

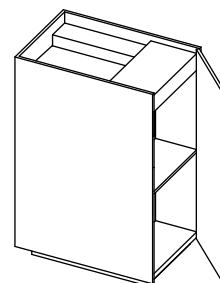

**FSC21**  
w840 x d400 x h900mm  
bowl width 616mm

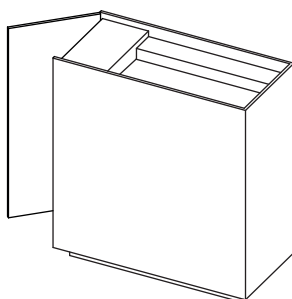

**FSC31**  
w840 x d400 x h900mm  
bowl width 616mm

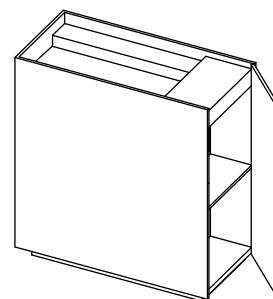

**FSC22**  
w1000 x d400 x h900mm  
bowl width 776mm

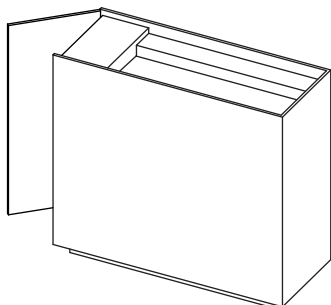

**FSC32**  
w1000 x d400 x h900mm  
bowl width 776mm

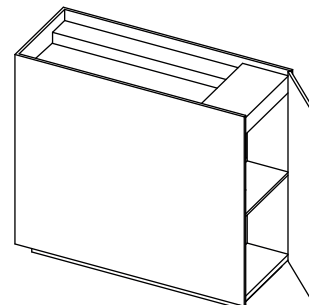

**FSC23**  
w1200 x d400 x h900mm  
bowl width 976mm

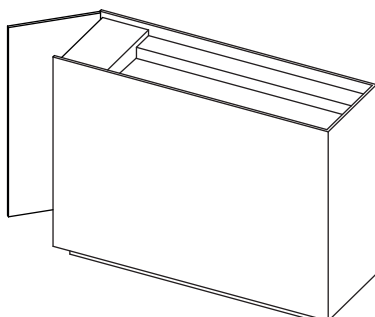

**FSC33**  
w1200 x d400 x h900mm  
bowl width 976mm

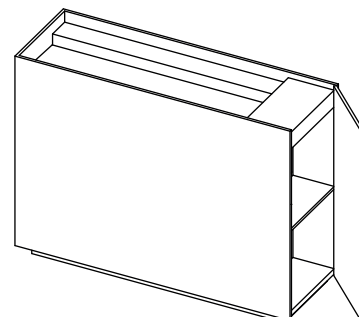

## Specifications

- delivered in White Himacs
- Neolith Blanco Carrara interior
- floor-standing with adjustable feet
- with integrated cabinet with access hatch
- to be placed against wall (back side is open)

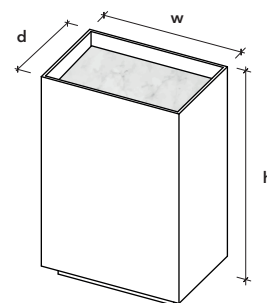

**FSC40**  
w600 x d400 x h900mm  
bowl width 576mm

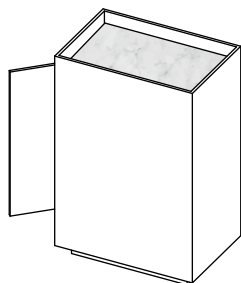

**FSC50**  
w600 x d400 x h900mm  
bowl width 576mm

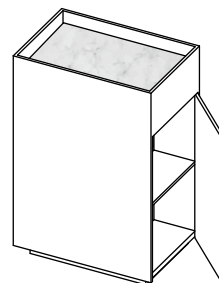

**FSC41**  
w840 x d400 x h900mm  
bowl width 816mm

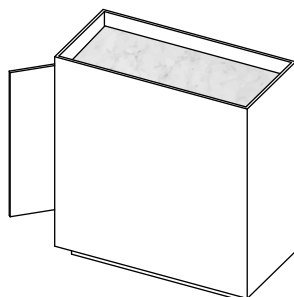

**FSC51**  
w840 x d400 x h900mm  
bowl width 816mm

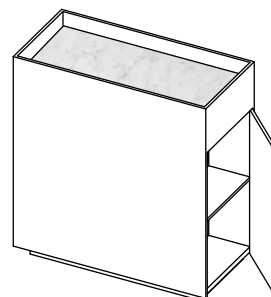

**FSC42**  
w1000 x d400 x h900mm  
bowl width 976mm

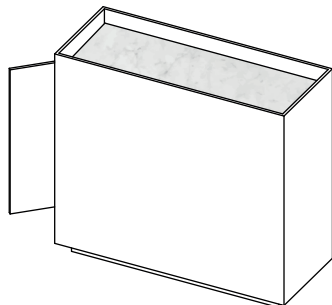

**FSC52**  
w1000 x d400 x h900mm  
bowl width 976mm

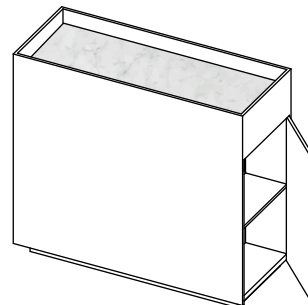

**FSC43**  
w1200 x d400 x h900mm  
bowl width 1176mm

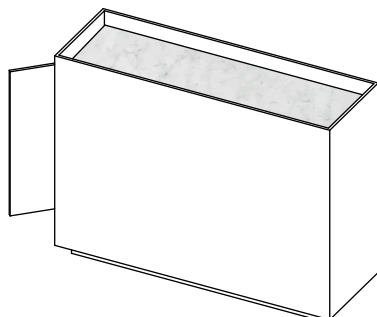

**FSC53**  
w1200 x d400 x h900mm  
bowl width 1176mm

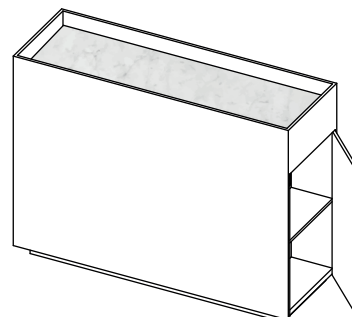

## Specifications

- delivered in Black Himacs
- Neolith Blanco Carrara interior
- floor-standing with adjustable feet
- with integrated cabinet with access hatch
- to be placed against wall (back side is open)

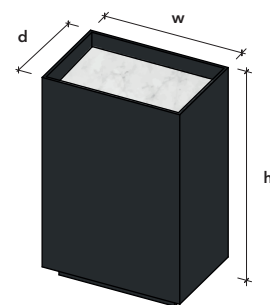

**FSC60**  
w600 x d400 x h900mm  
bowl width 576mm

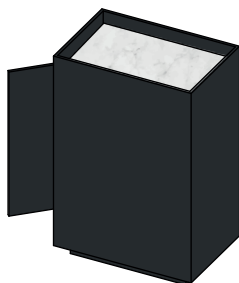

**FSC70**  
w600 x d400 x h900mm  
bowl width 576mm

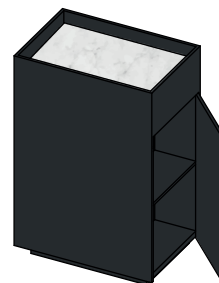

**FSC61**  
w840 x d400 x h900mm  
bowl width 816mm

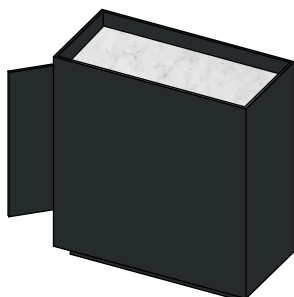

**FSC71**  
w840 x d400 x h900mm  
bowl width 816mm

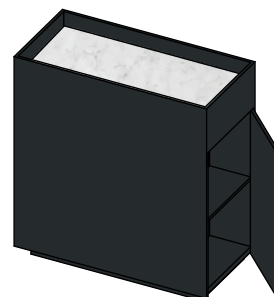

**FSC62**  
w1000 x d400 x h900mm  
bowl width 976mm

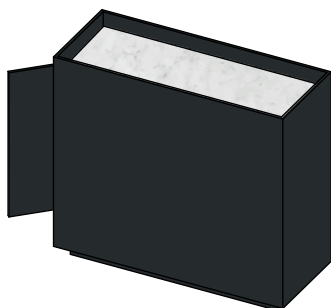

**FSC72**  
w1000 x d400 x h900mm  
bowl width 976mm

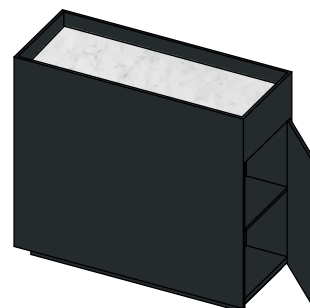

**FSC63**  
w1200 x d400 x h900mm  
bowl width 1176mm

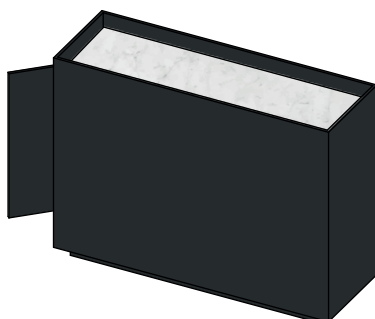

**FSC73**  
w1200 x d400 x h900mm  
bowl width 1176mm

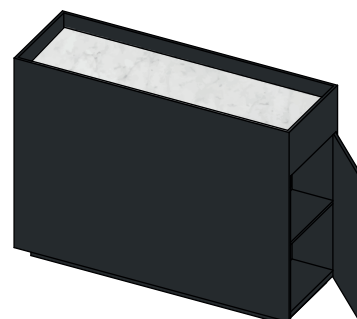



# Still oval



---

Still collection is a serie of circular and ovoidal shapes, each with a thin edge of 5mm, that radiate a certain lightness.

Made of Velluto® biobased, the velvet touch of the material emphasizes the softness of the spacious bowls. The timeless shapes make this collection an everyday classic, for any style.

Still collection is perfectly suitable for residential as well as commercial projects. Especially with our Palette finish and haptic Soft Touch coating unique designs can be created that suit your bathroom design.

- White Velluto® biobased
- with Palette finish
- with Soft Touch coating
- with Soft Touch coating 'Clairz color'

# Still oval

Still Models

## Specifications

- including free flow waste kit with Velluto® drain cover
- countertop model
- optional: Palette finish in custom NCS or RAL color
- optional: Soft Touch coating in custom NCS or RAL color

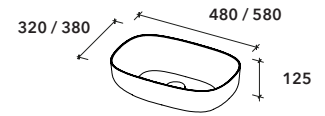

d320mm

**STL4832**  
w480 x d320 x h125mm  
white



**STL4832-PWCLAY**  
w480 x d320 x h125mm  
Palette finish in Warm Clay



**STL4832-PNCS / STL4832-PRAL**  
w480 x d320 x h125mm  
Palette finish in custom color

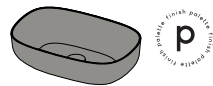

**STL4832-SNCS / STL4832-SRAL**  
w480 x d320 x h125mm  
Soft Touch finish in custom color



d380mm

**STL4832**  
w480 x d320 x h125mm  
white

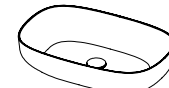

**STL5838-PWCLAY**  
w580 x d380 x h125mm  
Palette finish in Warm Clay

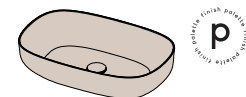

**STL5838-PNCS / STL5838-PRAL**  
w580 x d380 x h125mm  
Palette finish in custom color

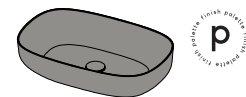

**STL5838-SNCS / STL5838-SRAL**  
w580 x d380 x h125mm  
Soft Touch coating in custom color

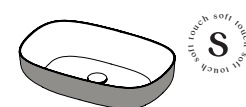

**STL5838-SCZ**  
w580 x d380 x h125mm  
Soft Touch coating in 'CLAIRZ' color

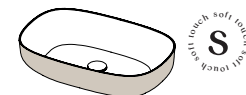

## Materials and colors

Velluto®  
biobased

- White
- with Palette finish in custom NCS or RAL color possible
- with Soft Touch coating in custom NCS or RAL color possible

## Drain type

Still is delivered with matching free flow Velluto® drain cover. See drawing below.

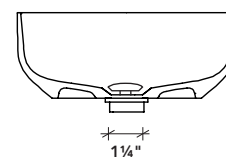





# Still round



---

Still collection is a serie of circular and ovoidal shapes, each with a thin edge of 5mm, that radiate a certain lightness.

Made of Velluto® biobased, the velvet touch of the material emphasizes the softness of the spacious bowls. The timeless shapes make this collection an everyday classic, for any style.

Still collection is perfectly suitable for residential as well as commercial projects. Especially with our Palette finish and haptic Soft Touch coating unique designs can be created that suit your bathroom design.

- White Velluto® biobased
- with Palette finish
- with Soft Touch coating

# Still round

Still Models

## Specifications

- including free flow waste kit with Velluto® drain cover
- countertop model
- optional: Palette finish in custom NCS or RAL color
- optional: Soft Touch coating in custom NCS or RAL color

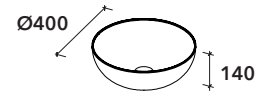

	Ø400mm	
STL400 Ø400 x h140mm white		
STL400-PWCLAY Ø400 x h140mm Palette finish in Warm Clay		
STL400-PDBLACK Ø400 x h140mm Palette finish in Deep Black		
STL400-PNCS / STL400-PRAL Ø400 x h140mm Palette finish in custom color		
STL400-SNCS / STL400-SRAL Ø400 x h140mm Soft Touch finish in custom color		

## Materials and colors

- Velluto®  
biobased**
- White
  - with Palette finish in custom NCS or RAL color possible
  - with Soft Touch coating in custom NCS or RAL color possible

## Drain type

Still is delivered with matching free flow Velluto® drain cover. See drawing below.

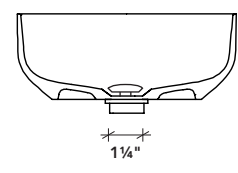



# Leaf



---

A modest design, that matches with all our basins.

At Not Only White we aim to keep it simple. But always distinctive. This is how our Leaf tap series was born.

What makes this design appealing is the 5cm long lever with rounded grip for easy use. The shape of the lever is inspired on the leaves of the Pagoda tree.

Design by Marike Andeweg

## Specifications

- deck mounted single lever mixer tap
- including 3/8" GAS warm and cold water fitting
- satin stainless steel



LF10122-SA  
h220mm

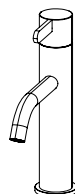

## Materials and colors

Satin stainless steel



# Leaf



A modest design, that matches with all our basins. At Not Only White we aim to keep it simple. But always distinctive. This is how our Leaf tap series was born.

● Stainless steel

What makes this design appealing is the 5cm long lever with rounded grip for easy use. The deck mounted mixer is flexible when it comes to its position on the surface.

The shape of the lever is inspired on the leaves of the Pagoda tree.

design by Marike Andeweg

## Specifications

- deck mounted spout with 1/2" fitting
- deck mounted single lever basin mixer with 3/8"GAS warm and cold water fitting
- available as separate items or in sets
- satin stainless steel

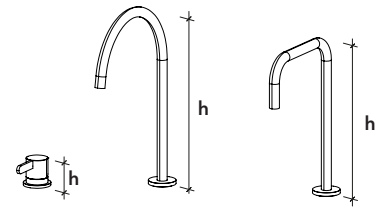

**LFSET01-SA**  
h350mm  
rounded spout + mixer

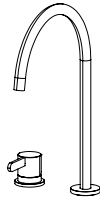

**LF241-SA**  
h350mm  
rounded spout

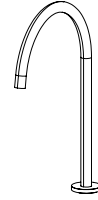

**LFSET02-SA**  
h300mm  
edged spout + mixer

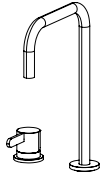

**LF235-SA**  
h300mm  
edged spout

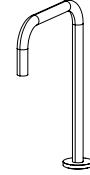

**LF711-SA**  
h57xØ40mm  
single lever basin mixer



## Materials and colors

Satin stainless steel



# Axis



The Axis bath is a free-standing, rectangular bath with rounded internal lines. The sloping side, combined with its generous proportions, makes the Axis a wonderfully comfortable bath tub. The overflow is subtly integrated within the tub and the drain plug is made of the same material as the bath.

Axis bath is made of Velluto® biobased, which can be perfectly combined with the white Himacs of our Not Only White custom made basins.

## Specifications

- including pop-up waste kit with Velluto® cover and 1 1/2" bottle trap
- with integrated overflow
- not fit for third party fill or overflow systems
- optional: Palette finish in NCS or RAL color
- optional: Soft Touch coating in NCS or RAL color

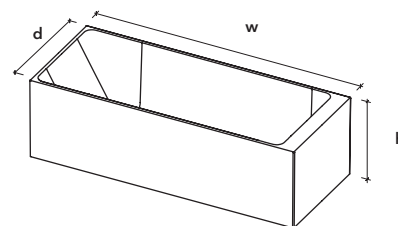

**FAX01**  
**w1680 x d680 x h500mm**  
 white  
 capacity at overflow level 310 liters  
 net weight ±174kg

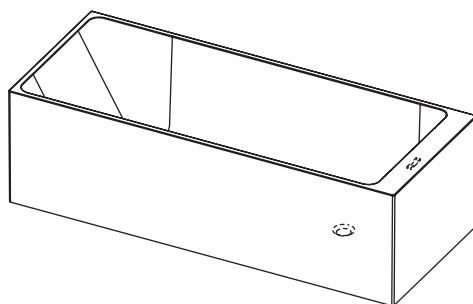

**FAX01-PNCS / FAX01-PRAL**  
**w1680 x d680 x h500mm**  
 Palette finish - custom color  
 capacity at overflow level 310 liters  
 net weight ±174kg

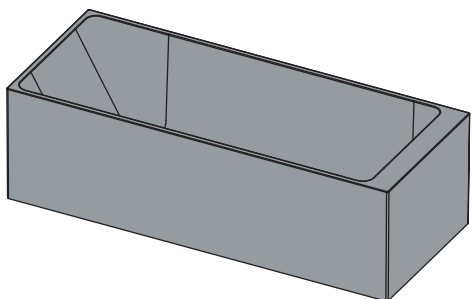

**FAX01-SNCS / FAX01-SRAL**  
**w1680 x d680 x h500mm**  
 Soft Touch coating - custom color  
 capacity at overflow level 310 liters  
 net weight ±174kg

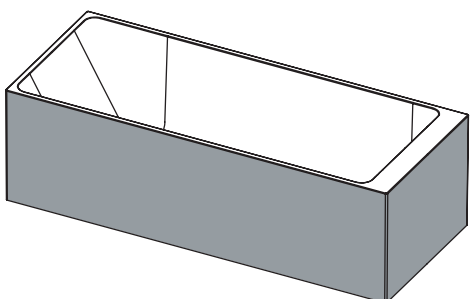

## Materials and colors

Velluto® biobased

- White
- with Palette finish in NCS or RAL color
- with Soft Touch coating in NCS or RAL color

# Ease

---

Ease bath is best described as a warmly, playful asymmetrical design but with an almost sculptural appearance. Because of its compact dimensions this bath fits easily in smaller bathrooms while keeping its spacious, luxurious look.

With its comfortable inner lines, Ease bath creates a wonderful bathing experience. And when not in use, a beautiful object to look at.



**Specifications**

- including pop-up waste kit with Velluto® drain cover and 1 ½" bottle trap
- with integrated overflow
- not fit for third party fill or overflow systems
- capacity at overflow level 266 liters
- net weight ±x100kg
- optional: Palette finish in custom NCS or RAL color possible
- optional: Soft Touch coating in custom NCS or RAL color possible

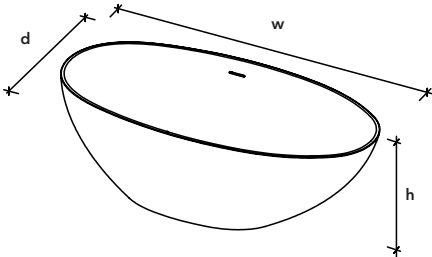

**FEA02**  
w1600 x d750x x h550mm  
white

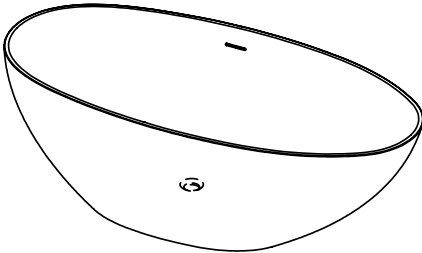

**FEA02-PNCS / FEA02-PRAL**  
w1600 x d750x x h550mm  
Palette finish - custom color

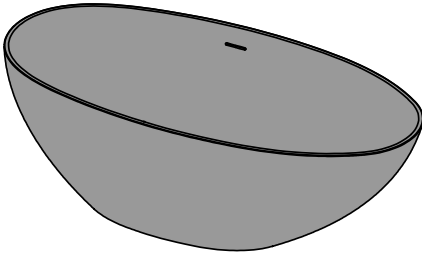

**FEA02-SNCS / FEA02-SRAL**  
w1600 x d750x x h550mm  
Soft Touch coating - custom color

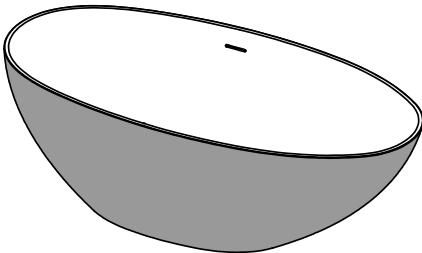

**Materials and colors**

Velluto® biobased

- White
- with Palette finish in custom NCS or RAL color
- with Soft Touch coating in custom NCS or RAL color



# Fine



---

Because of its thin lines and gentle curved design, our Fine baths appears light and soft. As precious earthenware. Just by looking at Fine, you can instantly feel a summer breeze entering your bathroom. Fine bath is available in 3 sizes, to make sure there is always the right dimensions to create harmony between bath and space.

Fine is made in white Velluto® biobased. Play with color and add another layer of luxury into your bathroom by using our unique Palette finish. Palette is easy to clean and UV resistant. Because of the availability in custom NCS and RAL colors, you can create a distinctive aesthetic appearance with our Fine bath. At home or in a hotel.

- White Velluto® biobased
- with Palette finish
- with Soft Touch coating

## Specifications

- including pop-up waste kit with Velluto® drain cover and 1 ½" bottle trap
- with integrated overflow
- not fit for third party fill or overflow systems
- capacity at overflow level 238 liters
- net weight ±82kg
- optional: Palette finish in NCS or RAL color possible
- optional: Soft Touch coating in NCS or RAL color possible

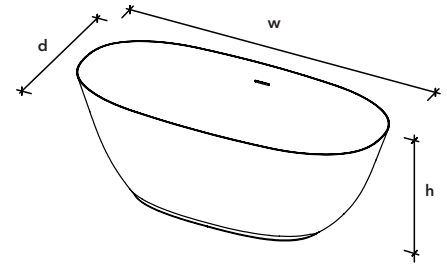

**FFI02**  
w1600 x d700 x h580mm  
white

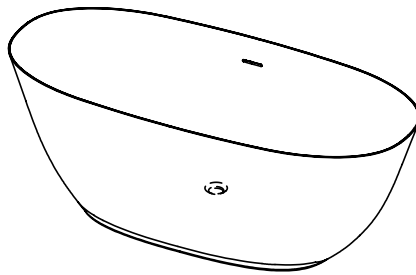

**FFI02-PNCS / FFI02-PRAL**  
w1600 x d700 x h580mm  
Palette finish - custom color

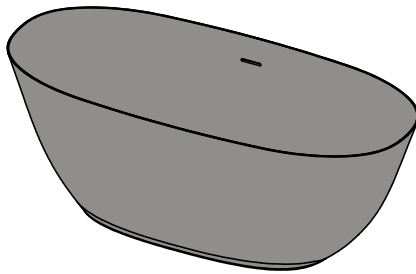

**FFI02-SNCS / FFI02-SRAL**  
w1600 x d700 x h580mm  
Soft Touch coating - custom color

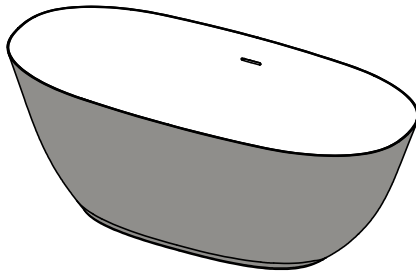

## Materials and colors

### Velluto® biobased

- White
- with Palette finish in custom NCS or RAL color
- with Soft Touch coating in custom NCS or RAL color

## Specifications

- including pop-up waste kit with Velluto® drain cover and 1 1/2" bottle trap
- with integrated overflow
- not fit for third party fill or overflow systems
- capacity at overflow level 271 liters
- net weight ±127kg
- optional: Palette finish in NCS or RAL color possible
- optional: Soft Touch coating in NCS or RAL color possible

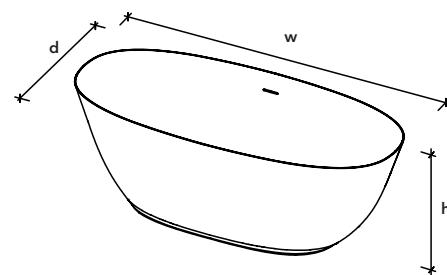

**FFI03**  
w1700 x d750 x h580mm  
white

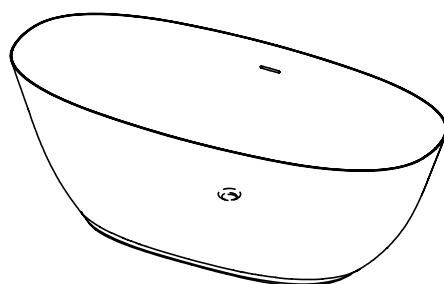

**FFI03-PNCS / FFI03-PRAL**  
w1700 x d750 x h580mm  
Palette finish - custom color

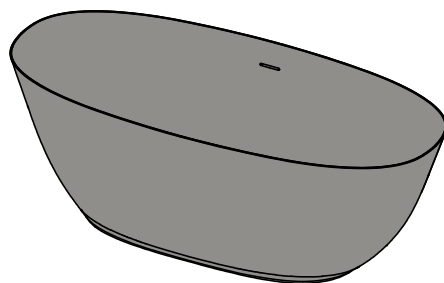

**FFI03-SNCS / FFI03-SRAL**  
w1700 x d750 x h580mm  
Soft Touch coating - custom color

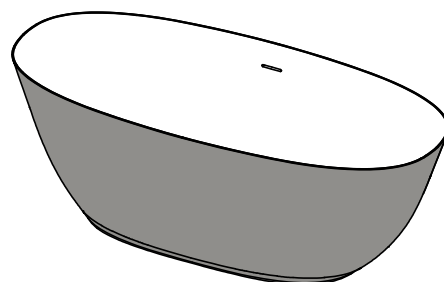

## Materials and colors

Velluto® biobased

- White
- with Palette finish in custom NCS or RAL color
- with Soft Touch coating in custom NCS or RAL color

## Specifications

- including pop-up waste kit with Velluto® drain cover and 1 ½" bottle trap
- with integrated overflow
- not fit for third party fill or overflow systems
- capacity at overflow level 316 liters
- net weight ±142kg
- optional: Palette finish in NCS or RAL color possible
- optional: Soft Touch coating in NCS or RAL color possible

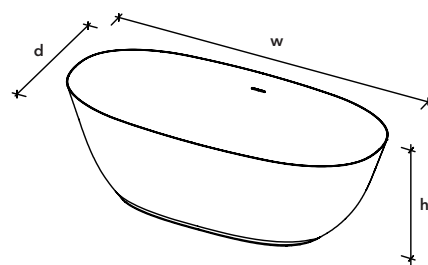

**FFI04**  
**w1800 x d800 x h580mm**  
 white

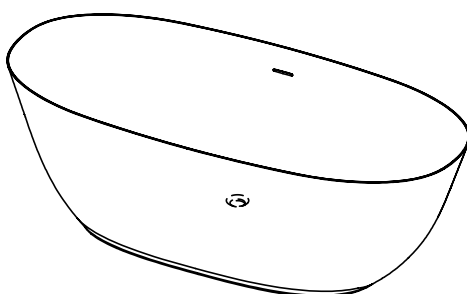

**FFI04-PNCS / FFI04-PRAL**  
**w1800 x d800 x h580mm**  
 Palette finish - custom color

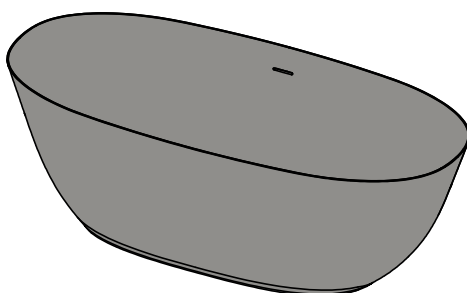

**FFI04-SNCS / FFI04-SRAL**  
**w1800 x d800 x h580mm**  
 Soft Touch coating - custom color

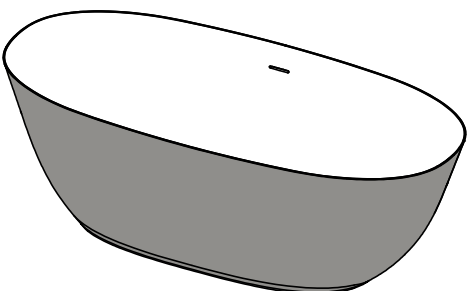

## Materials and colors

Velluto® biobased

- White
- with Palette finish in custom NCS or RAL color
- with Soft Touch coating in custom NCS or RAL color





# Loop



Loop FLP01  
Private residence  
Interior design by Studio Niels  
Photography by Serge Technau

---

This free-standing egg-shaped bath is all about an elegant play of lines. The overflow is subtly integrated within the tub and the drain plug is in the same material as the bath.

Loop bath is made of Velluto® biobased. Especially designed for the Loop bath, the Loop bath tray hugs the curves of the tub. With one's favourite magazine, candle and drink within easy reach, bathing is more relaxing than ever.

- White Velluto® biobased
- with Palette finish
- with Soft Touch coating

# Loop

## Loop Models

### Specifications

- including pop-up waste kit with white Velluto® drain cover and 1 ½" bottle trap
- with integrated overflow
- not fit for third party fill or overflow systems
- capacity at overflow level 310 liters
- net weight ±102kg
- optional: Palette finish in NCS or RAL color possible
- optional: Soft Touch coating in NCS or RAL color possible

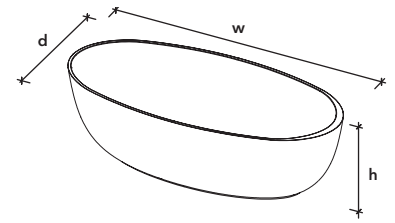

**FLP01**  
w1690 x d800 x h500mm  
white

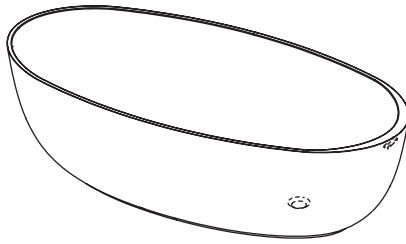

**FLP01-PNCS / FLP01-PRAL**  
w1690 x d800 x h500mm  
Palette finish - custom color

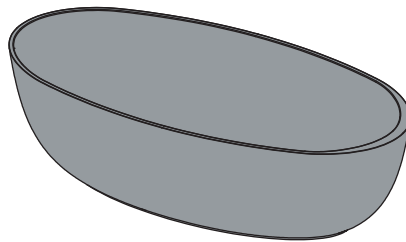

**FLP01-SNCS / FLP01-SRAL**  
w1690 x d800 x h500mm  
Soft Touch coating - custom color

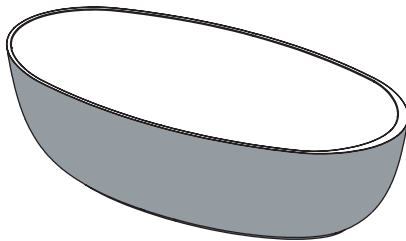

### Materials and colors

Velluto® biobased

- White
- with Palette finish in custom NCS or RAL color
- with Soft Touch coating in custom NCS or RAL color

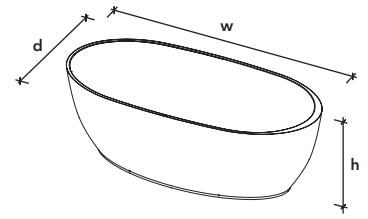

## Specifications

- including pop-up waste kit with white Velluto® drain cover and 1 1/2" bottle trap
- with integrated overflow
- not fit for third party fill or overflow systems
- capacity at overflow level 247 liters
- net weight ±90kg
- optional: Palette finish in NCS or RAL color possible
- optional: Soft Touch coating in NCS or RAL color possible

**FLP03**  
w1500 x d700 x h500mm  
white

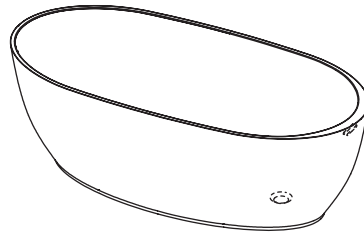

**FLP03-PNCS / FLP03PRAL**  
w1500 x d700 x h500mm  
Palette finish - custom color

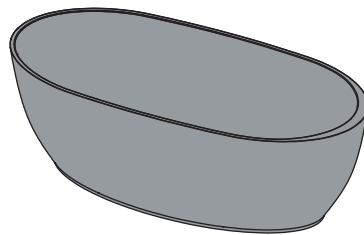

**FLP03-SNCS / FLP03-SRAL**  
w1500 x d700 x h500mm  
Soft Touch coating - custom color

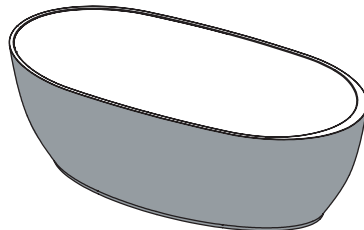

## Materials and colors

Velluto® biobased

- White
- with Palette finish in custom NCS or RAL color
- with Soft Touch coating in custom NCS or RAL color

# Muse



---

Muse bath is an ode to bathing. Noble and modest at the same time. Simple, straight outlines and generous on the inside. Balanced proportions and with a very comfortable support at both sides.

Muse is made in white Velluto®. Play with color and add another layer of luxury into your bathroom by using our unique Palette finish. Palette is easy to clean and UV resistant. Because of the availability in many colors, you can create a distinctive aesthetic appearance with our Muse bath. At home or in a hotel.

## Specifications

- including pop-up waste kit with white Velluto® cover and 1 ½" bottle trap
- with integrated overflow
- not fit for third party fill or overflow systems
- capacity at overflow level 318 liters
- net weight ±101kg
- optional: Palette finish in custom NCS or RAL color possible
- optional: Soft Touch coating in custom NCS or RAL color possible

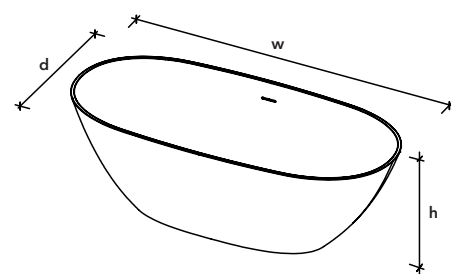

**FMU04**  
w1770 x d800 x h565mm  
white

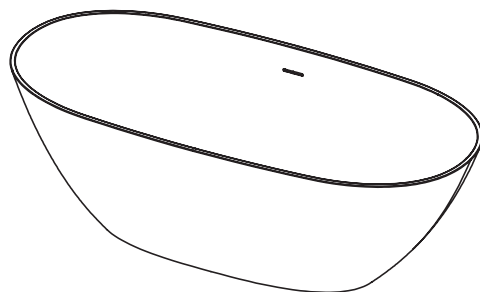

**FMU04-PNCS / FMU04-PRAL**  
w1770 x d800 x h565mm  
Palette finish - custom color

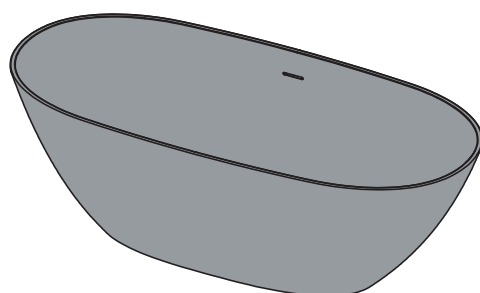

**FMU04-SNCS / FMU04-SRAL**  
w1770 x d800 x h565mm  
Soft Touch coating - custom color

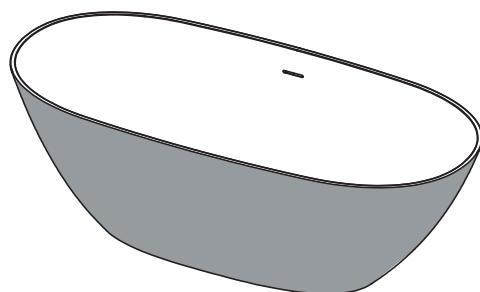

## Materials and colors

**Velluto® biobased**

- White
- with Palette finish in custom NCS or RAL color
- with Soft Touch coating in custom NCS or RAL color

Bath tray



### Specifications

- available in white, grey or concrete Himacs

---

#### Axis bath tray

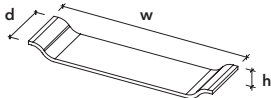

**AAXTR 01**  
w685 x d175 x h52mm  
bath tray for Axis FAX01

---

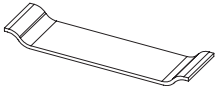

**AAXTR 02**  
w740 x d175 x h52mm  
bath tray for Axis FAX02

---

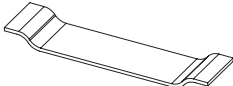

---

#### Loop bath tray

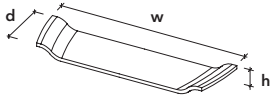

**ALPTR01**  
w700 x d175 x h44mm  
bath tray for Loop FLP01

---



**ALPTR03**  
w670 x d175 x h44mm  
bath tray for Loop FLP03

---

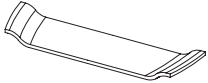

### Materials and colors

- Himacs
- White
  - Grey
  - Concrete

# Base handrinse



---

As the name suggests, the Base handrinse is a collection of basic-shaped models. It is characterized by the 12mm radius inside the basin.

This collection aims to be accessible, adaptable and easy to maintain. Not only is Base perfect for the domestic environment, but its characteristics also make Base an ideal choice in hygienic surroundings and intensively-used restrooms.

Design by Marike Andeweg

## Specifications

- delivered with our Flush drain
- delivered as wall-mounted version including mounting holes in the back edge
- standard size tap hole Ø30mm; for UK Ø35mm
- Base handrinse Models are also available in top-mounted versions

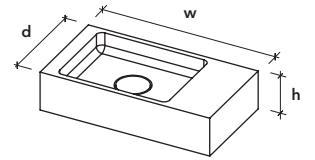

d200mm - no tap hole

**HBS01**  
w300 x d200 x h85mm  
bowl w240 x d176 x h40mm

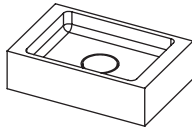

d200mm - with tap hole

**HBS07**  
w370 x d200 x h85mm  
bowl w240 x d176 x h40mm

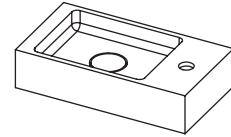

**HBS02**  
w300 x d200 x h130mm  
bowl w240 x d176 x h60mm

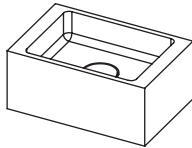

**HBS08**  
w370 x d200 x h130mm  
bowl w240 x d176 x h60mm

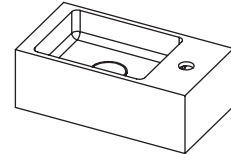

**HBS03**  
w300 x d200 x h85mm  
bowl w240 x d176 x h40mm

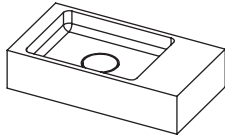

**HBS09**  
w370 x d200 x h85mm  
bowl w240 x d176 x h40mm

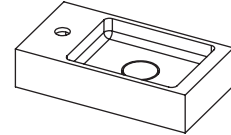

**HBS04**  
w370 x d200 x h130mm  
bowl w240 x d176 x h60mm

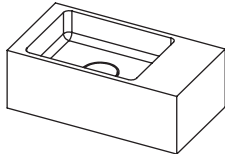

**HBS10**  
w370 x d200 x h130mm  
bowl w240 x d176 x h60mm

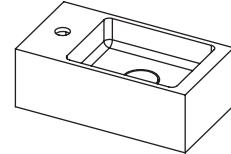

**HBS05**  
w370 x d200 x h85mm  
bowl w240 x d176 x h40mm

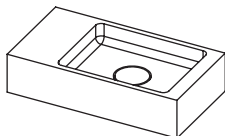

**HBS06**  
w370 x d200 x h130mm  
bowl w240 x d176 x h60mm

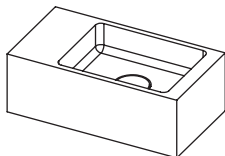

## Materials and colors

Himacs

○ White

# Base Light handrinse



---

Base Light handrinse is the slim sibling of the Base handrinse collection. With an overall depth of 14 centimeters and a wall thickness and inside radius of only 9 millimeters, Base Light is the compact solution for small spaces.

This collection aims to be accessible, adaptable and easy to maintain. Base Light is perfect for the domestic environment.

Design by Marike Andeweg

## Specifications

- delivered with our Flush drain
- delivered as wall-mounted version including mounting holes in the back edge
- standard size tap hole Ø30mm; for UK Ø35mm
- Base Light handrinse Models are also available in top-mounted versions

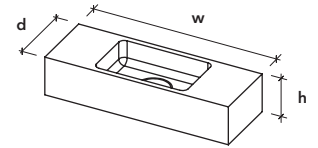

d140mm - no tap hole

**HBS11**  
w400 x d140 x h85mm  
bowl w200 x d122 x h50mm

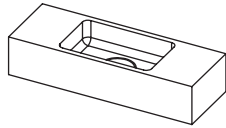

d140mm - with tap hole

**HBS16**  
w400 x d140 x h85mm  
bowl w200 x d122 x h50mm

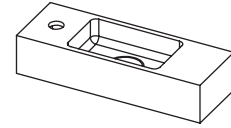

**HBS17**  
w400 x d140 x h85mm  
bowl w200 x d122 x h50mm

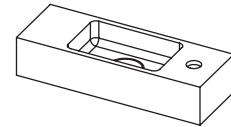

**HBS12**  
w500 x d140 x h85mm  
bowl w200 x d122 x h50mm

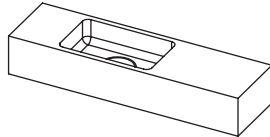

**HBS18**  
w500 x d140 x h85mm  
bowl w200 x d122 x h50mm

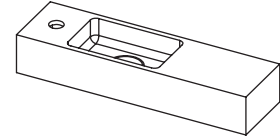

**HBS13**  
w600 x d140 x h85mm  
bowl w200 x d122 x h50mm

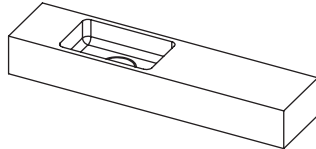

**HBS19**  
w600 x d140 x h85mm  
bowl w200 x d122 x h50mm

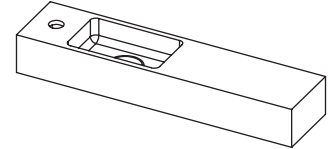

**HBS14**  
w500 x d140 x h85mm  
bowl w200 x d122 x h50mm

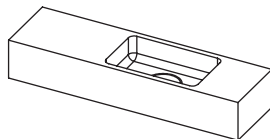

**HBS20**  
w500 x d140 x h85mm  
bowl w200 x d122 x h50mm

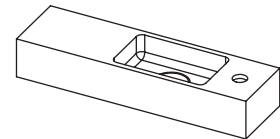

**HBS15**  
w600 x d140 x h85mm  
bowl w200 x d122 x h50mm

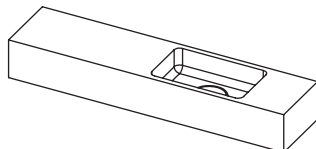

**HBS21**  
w600 x d140 x h85mm  
bowl w200 x d122 x h50mm

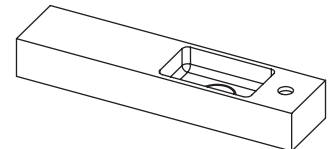

## Materials and colors

Himacs

○ White

# Base Bold handrinse



---

Base Bold handrinse is the big brother of the Base handrinse collection. The bigger bowl gives you a bit more space to freshen up.

The Base Bold handrinse is like the other models in this collection: accessible, adaptable and easy to maintain. A welcome solution for your sanitary space.

Design by Marike Andeweg

## Specifications

- delivered with our Flush drain
- delivered as wall-mounted version including mounting holes in the back edge
- standard size tap hole Ø30mm; for UK Ø35mm
- Base Bold handrinse Models are also available in top-mounted versions

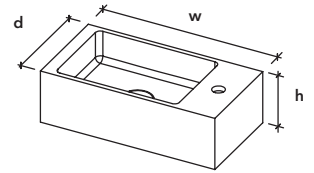

### d224m - no tap hole

**HBS31**  
w360 x d224 x h130mm  
bowl w300 x d200 x h75mm

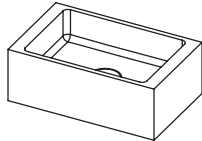

**HBS32**  
w360 x d224 x h145mm  
bowl w300 x d200 x h100mm

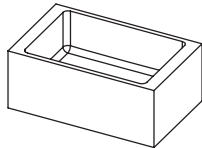

**HBS33**  
w430 x d224 x h130mm  
bowl w300 x d200 x h75mm

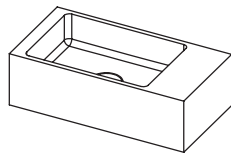

**HBS34**  
w430 x d224 x h145mm  
bowl w300 x d200 x h100mm

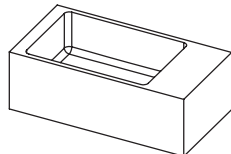

**HBS35**  
w430 x d224 x h130mm  
bowl w300 x d200 x h75mm

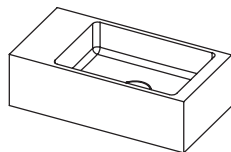

**HBS36**  
w430 x d224 x h145mm  
bowl w300 x d200 x h100mm

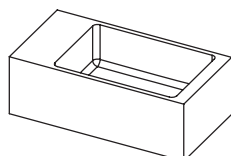

### d224mm - with tap hole

**HBS37**  
w430 x d224 x h130mm  
bowl w300 x d200 x h75mm

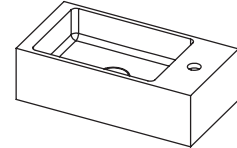

**HBS38**  
w430 x d224 x h145mm  
bowl w300 x d200 x h100mm

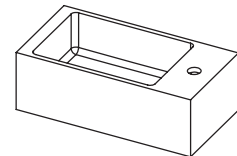

**HBS39**  
w430 x d224 x h130mm  
bowl w300 x d200 x h75mm

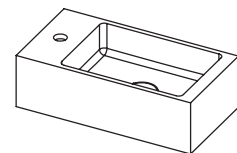

**HBS40**  
w430 x d224 x h145mm  
bowl w300 x d200 x h100mm

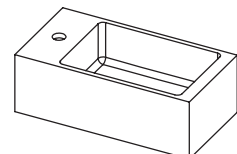

## Materials and colors

Himacs

○ White

# Base handrinse

Base / Base Light / Base Bold handrinse Custom Made

## Handrinse layout

Make a choice between Base, Base Light or Base Bold handrinse and fill in positions 1 and 2.  
After this define the size of the bowl. Go to page 101 for the bowl sizes.

### BASE

- ① max. 2000mm
- ② min. 30mm  
min. 80mm with tap hole

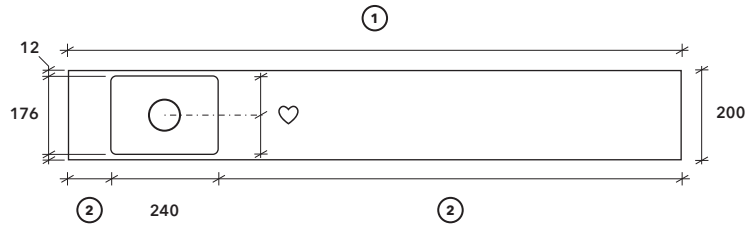

### BASE LIGHT

- ① max. 2000mm
- ② min. 30mm  
min. 80mm with tap hole

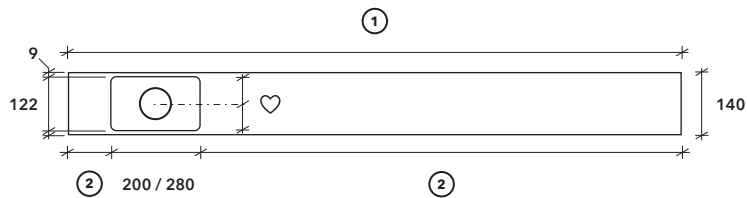

### BASE BOLD

- ① max. 2000mm
- ② min. 30mm  
min. 80mm with tap hole

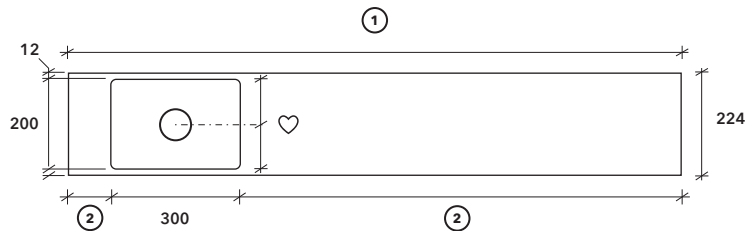

## Edge

Base, Base Light and Base Bold handrinse always come with a front and back edge. In order to conceal the bowl, Not Only White recommends an edge height as mentioned on the next page at the 'Bowls' section.

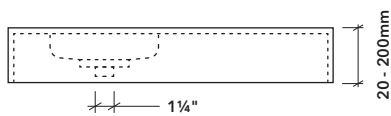

### EH100

Edge 20 - 100mm high

### EH150

Edge 101 - 150mm high

### EH200

Edge 151 - 200mm high

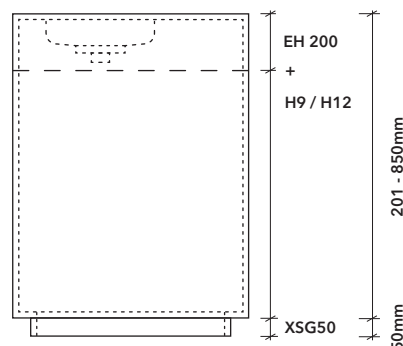

### EH200 + remaining m<sup>2</sup> in H9 for Base Light

Edge 201 - 850mm high

### EH200 + remaining m<sup>2</sup> in H12 for Base and Base Bold

Edge 201 - 850mm high

### XSG50

50mm plinth for floor-standing model

## Bowls

### Base handrinse bowl for basin d200mm

#### CHBS24174

w240x d176 x h40mm  
rec. edge height 85mm



#### CHBS24176

w240x d176 x h60mm  
rec. edge height 105mm



#### CHBS241710

w240x d176 x h100mm  
rec. edge height 145mm



### Base Light handrinse bowl for basin d140mm

#### CHBSL20125

w200 x d122 x h50mm  
rec. edge height 95mm



#### CHBSL20128

w200 x d122 x h85mm  
rec. edge height 130mm



#### CHBSL28128

w280 x d122 x h85mm  
rec. edge height 130mm



### Base Bold handrinse bowl for basin d224mm

#### CHBS30205

w300 x d200 x h50mm  
rec. edge height 90mm

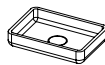

#### CHBS30207

w300 x d200 x h75mm  
rec. edge height 115mm

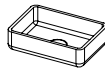

#### CHBS302010

w300 x d200 x h100mm  
rec. edge height 140mm

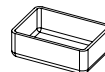

## Drain type

Depending on how the handrinse basin needs to look and work, you can choose from different drain types for Base handrinse.

### 1 FLUSH DRAIN free flow drain

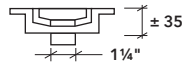

Base handrinse bowls are standard equipped with our Flush drain. This drain allows water to flow through at all times and cannot be closed.

Flush drain is free of charge

### 2 DR72 DRAIN HOLE for a third party drain

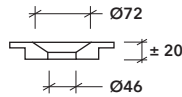

The DR72 drain hole is used for third party drains.

Not Only White recommends to use a free flow drain.

DR72 drain is free of charge

## Overflow

An overflow is not possible.

## Tap hole

If you need to fit a top-mounted tap, we can pre-drill the hole (code **HH35**).

Consider the space you would need to secure the tap with a tightening ring.

### Top-mounted tap without overflow:

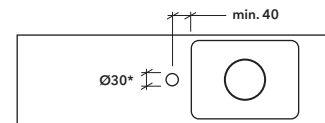

\* Tap hole for UK 35mm

## Mounting holes

To install a handrinse basin to the wall, Not Only White can provide mounting holes (code **OVHL**) in the back edge.

Handrinse basins up to 600mm need two holes. Any handrinse basin wider than 600mm, we advise to have an extra hole up to 1.2m and two extra holes up to 2m.



Please refer to **Ribs** for handrinse basins that need to be mounted on a cabinet. In this case mounting holes won't be needed.

## Ribs

Please refer to page 11.

## Cut-outs and edge finishes

Please refer to page 10.

## Materials and colors

Himacs

○ White



# Blend handrinse

---

The Blend handrinse is the smaller version of the Blend basin. The top of the organic-shaped basin fluidly forms the 6 centimeters high backsplash giving the Blend handrinse a nostalgic look.

The Blend handrinse is also available with an edge and both models are equipped with the Flush drain made out of Himacs, just like the basin itself.

Design by Marike Andeweg



## Specifications

- delivered with our Flush drain
- delivered as wall-mounted version including white powder coated bracket
- standard size tap hole Ø30mm; for UK Ø35mm

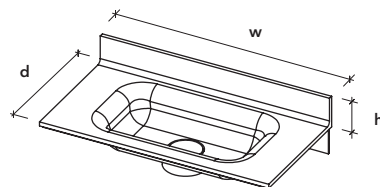

d260mm - no tap hole

**HBL02**  
w500 x d260 x h69mm  
bowl w290 x d144 x h60mm

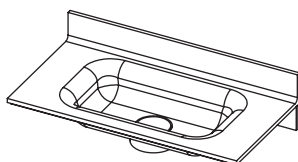

**HBL03**  
w600 x d260 x h69mm  
bowl w290 x d144 x h60mm

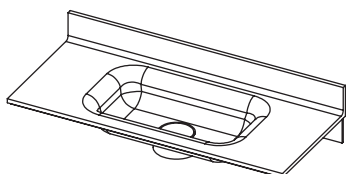

**HBL04**  
w500 x d260 x h69mm  
bowl w290 x d144 x h60mm

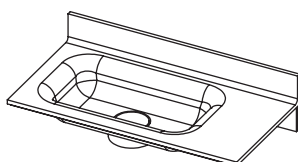

**HBL05**  
w600 x d260 x h69mm  
bowl w290 x d144 x h60mm

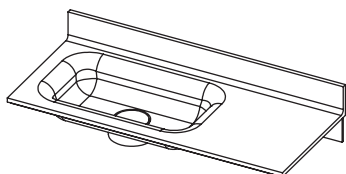

**HBL06**  
w500 x d260 x h69mm  
bowl w290 x d144 x h60mm

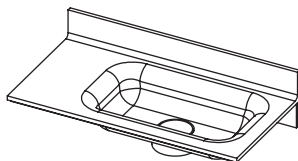

**HBL07**  
w600 x d260 x h69mm  
bowl w290 x d144 x h60mm

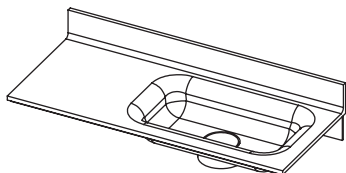

d260mm - with tap hole

**HBL08**  
w500 x d260 x h69mm  
bowl w290 x d144 x h60mm

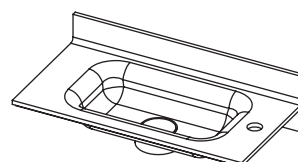

**HBL09**  
w500 x d260 x h69mm  
bowl w290 x d144 x h60mm

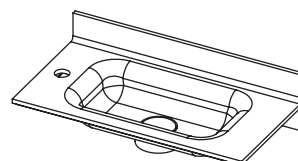

**HBL10**  
w600 x d260 x h69mm  
bowl w290 x d144 x h60mm

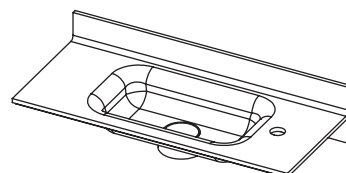

**HBL11**  
w600 x d260 x h69mm  
bowl w290 x d144 x h60mm

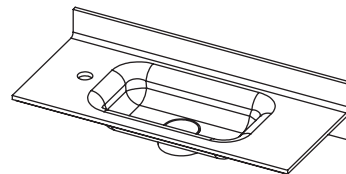

**HBL12**  
w500 x d260 x h69mm  
bowl w290 x d144 x h60mm

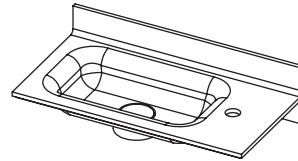

**HBL13**  
w600 x d260 x h69mm  
bowl w290 x d144 x h60mm

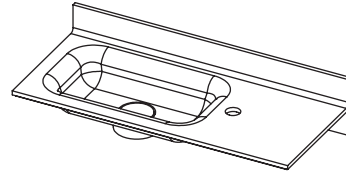

**HBL14**  
w500 x d260 x h69mm  
bowl w290 x d144 x h60mm

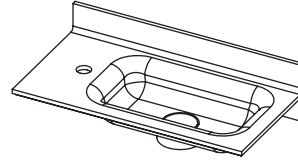

**HBL15**  
w600 x d260 x h69mm  
bowl w290 x d144 x h60mm

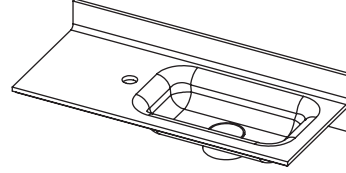

# Blend handrinse



---

What makes the Blend collection so special is the fusion of the organic-shaped bowl with the linear top. The invisible design of the Flush drain fits the Blend perfectly. Blend invites you to touch it.

The curved design of the bowl allows for easy maintenance.

Design by Marike Andeweg

## Specifications

- delivered with our Flush drain
- delivered as wall-mounted version including mounting holes in the back edge
- standard size tap hole Ø30mm; for UK Ø35mm
- Blend handrinse Models HBL16 -30 are also available in top-mounted versions

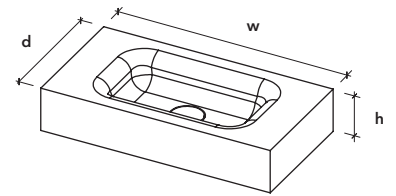

d260mm - no tap hole

d260mm - with tap hole

**HBL16**  
w405 x d260 x h95mm  
bowl w290 x d144 x h60mm

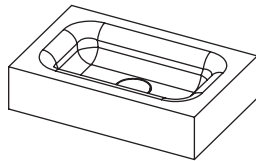

**HBL23**  
w500 x d260 x h95mm  
bowl w290 x d144 x h60mm

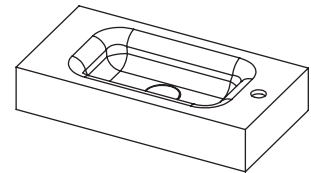

**HBL17**  
w500 x d260 x h95mm  
bowl w290 x d144 x h60mm

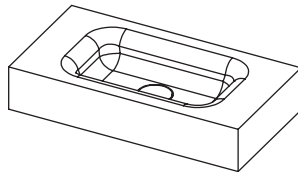

**HBL24**  
w500 x d260 x h95mm  
bowl w290 x d144 x h60mm

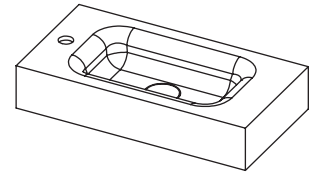

**HBL18**  
w600 x d260 x h95mm  
bowl w290 x d144 x h60mm

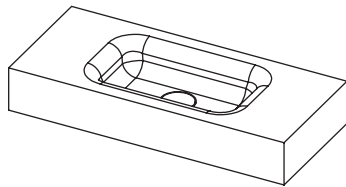

**HBL25**  
w600 x d260 x h95mm  
bowl w290 x d144 x h60mm

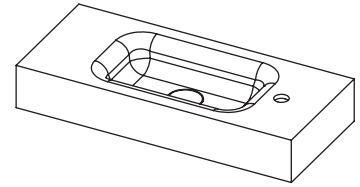

**HBL19**  
w500 x d260 x h95mm  
bowl w290 x d144 x h60mm

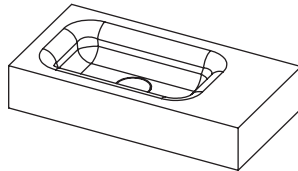

**HBL26**  
w600 x d260 x h95mm  
bowl w290 x d144 x h60mm

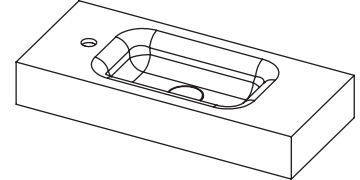

**HBL20**  
w600 x d260 x h95mm  
bowl w290 x d144 x h60mm

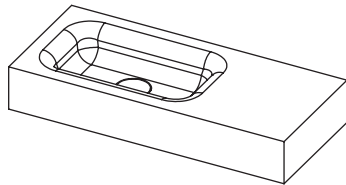

**HBL27**  
w500 x d260 x h95mm  
bowl w290 x d144 x h60mm

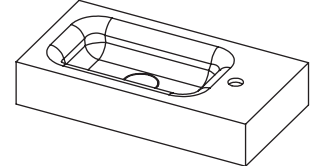

**HBL21**  
w500 x d260 x h95mm  
bowl w290 x d144 x h60mm

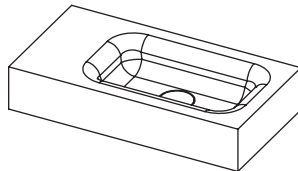

**HBL28**  
w600 x d260 x h95mm  
bowl w290 x d144 x h60mm

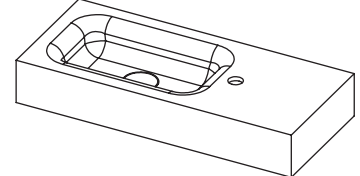

**HBL22**  
w600 x d260 x h95mm  
bowl w290 x d144 x h60mm

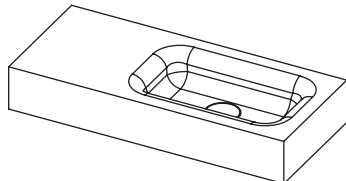

**HBL29**  
w500 x d260 x h95mm  
bowl w290 x d144 x h60mm

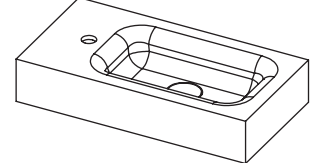

**HBL30**  
w600 x d260 x h95mm  
bowl w290 x d144 x h60mm

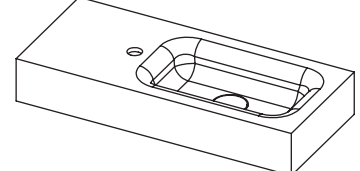

## Handrinse layout

Fill in positions 1-5.

- ① max. 5000mm
- ② max. 400mm
- ③ min. 30mm  
min. 75mm with tap hole
- ④ min. 30mm
- ⑤ min. 30mm  
min. 75mm with tap hole

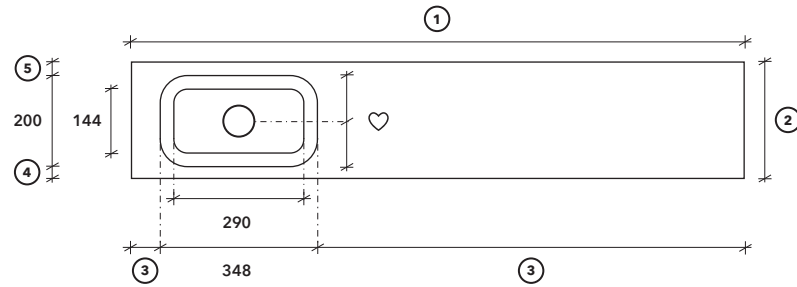

## Edge

Blend handrinse always comes with a front and back edge. In order to conceal the bowl, Not Only White recommends an edge height of 95mm.

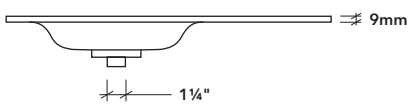

**H9**  
9mm top sheet

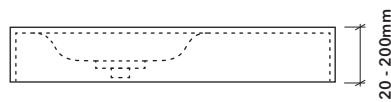

**EH100**  
Edge 20 - 100mm high

**EH150**  
Edge 101 - 150mm high

**EH200**  
Edge 151 - 200mm high

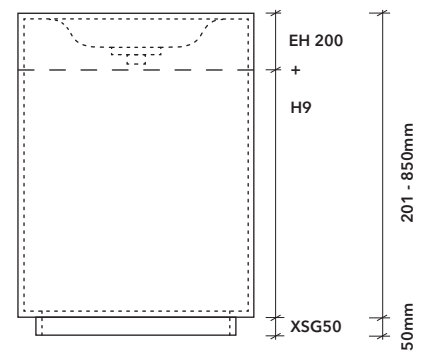

**EH200 + remaining m<sup>2</sup> in H9**  
Edge 201 - 850mm high

**XSG50**  
50mm plinth for floor-standing model

## Bowls

**CHBL29146**  
w348 x d200 x h60mm  
rec. edge height 95mm



## Drain type

Depending on how the handrinse basin needs to look and work, you can choose from different drain types for Blend handrinse.

① **FLUSH DRAIN**  
free flow drain

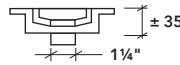

Blend handrinse bowls are standard equipped with our Flush drain. This drain allows water to flow through at all times and cannot be closed.

**Flush drain is free of charge**

② **DR72 DRAIN HOLE**  
for a third party drain

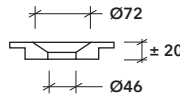

The DR72 drain hole is used for third party drains.

Not Only White recommends to use a free flow drain.

**DR72 drain is free of charge**

## Overflow

An overflow is not possible.

## Tap hole

If you need to fit a top-mounted tap, we can pre-drill the hole (code **HH35**).

Consider the space you would need to secure the tap with a tightening ring.

**Top-mounted tap without overflow:**

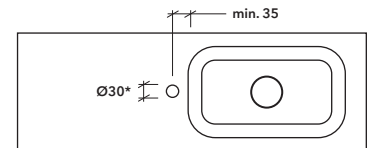

\* Tap hole for UK 35mm

## Mounting holes

To install a handrinse basin to the wall, Not Only White can provide mounting holes (code **OVHL**) in the back edge.

Handrinse basins up to 600mm need two holes. Any handrinse basin wider than 600mm, we advise to have an extra hole up to 1.2m and two extra holes up to 2m.

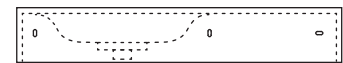

Please refer to **Brackets and ribs** for handrinse basins that need to be mounted on a cabinet and/or are deeper than 290mm. In this case mounting holes won't be needed.

## Brackets and ribs

Please refer to page 11, where brackets and ribs are explained, to find out what type of support is needed for your washbasin.

## Cut-outs and edge finishes

Please refer to page 10.

## Materials and colors

**Himacs** ○ White



# Form handrinse



---

The Form handrinse's linearity gives the collection its signature clean and serene look.

The rounded Flush drain, however, punctuates all the straight lines in a surprising and yet pleasing manner.

Design by Marike Andeweg

## Specifications

- delivered with our Flush drain
- delivered as wall-mounted version including mounting holes in the back edge
- standard size tap hole Ø30mm; for UK Ø35mm
- Form handrinse Models are also available in top-mounted versions

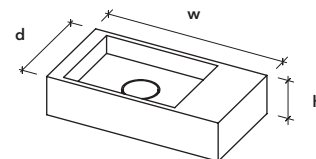

d200mm - no tap hole

**HFM01**  
w300 x d200 x h85mm  
bowl w240 x d176 x h40mm

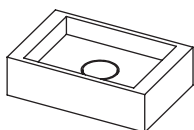

d200mm - with tap hole

**HFM07**  
w370 x d200 x h85mm  
bowl w240 x d176 x h40mm

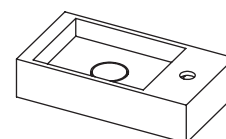

**HFM02**  
w300 x d200 x h130mm  
bowl w240 x d176 x h60mm

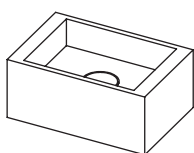

**HFM08**  
w370 x d200 x h130mm  
bowl w240 x d176 x h60mm

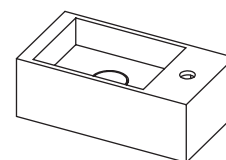

**HFM03**  
w370 x d200 x h85mm  
bowl w240 x d176 x h40mm

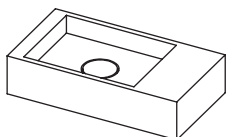

**HFM09**  
w370 x d200 x h85mm  
bowl w240 x d176 x h40mm

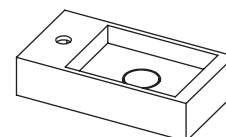

**HFM04**  
w370 x d200 x h130mm  
bowl w240 x d176 x h60mm

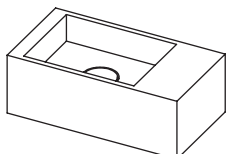

**HFM10**  
w370 x d200 x h130mm  
bowl w240 x d176 x h60mm

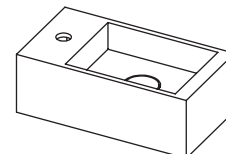

**HFM05**  
w370 x d200 x h85mm  
bowl w240 x d176 x h40mm

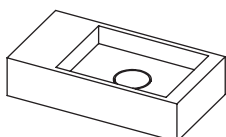

**HFM06**  
w370 x d200 x h130mm  
bowl w240 x d176 x h60mm

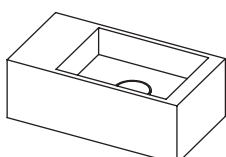

## Materials and colors

Himacs

○ White

# Form Light handrinse



---

The Form Light handrinse's linearity gives the collection its signature clean and serene look.

The rounded Flush drain, however, punctuates all the straight lines in a surprising and yet pleasing manner.

Its depth of only 14 centimeters make it the perfect choice for small spaces.

Design by Marike Andeweg

## Specifications

- delivered with our Flush drain
- delivered as wall-mounted version including mounting holes in the back edge
- standard size tap hole Ø30mm; for UK Ø35mm
- Form Light handrinse Models are also available in top-mounted versions

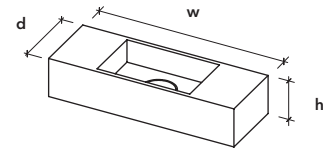

d140mm - no tap hole

**HFM11**  
w400 x d140 x h85mm  
bowl w200 x d122 x h50mm

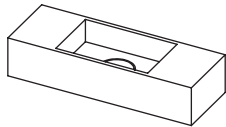

d140mm - with tap hole

**HFM16**  
w400 x d140 x h85mm  
bowl w200 x d122 x h50mm

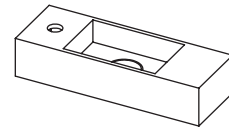

**HFM17**  
w400 x d140 x h85mm  
bowl w200 x d122 x h50mm

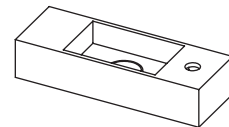

**HFM12**  
w500 x d140 x h85mm  
bowl w200 x d122 x h50mm

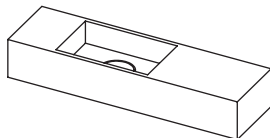

**HFM18**  
w500 x d140 x h85mm  
bowl w200 x d122 x h50mm

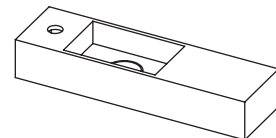

**HFM13**  
w600 x d140 x h85mm  
bowl w200 x d122 x h50mm

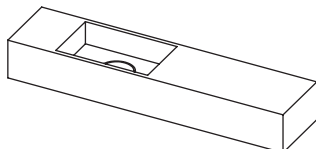

**HFM19**  
w600 x d140 x h85mm  
bowl w200 x d122 x h50mm

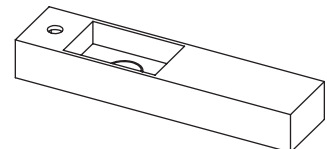

**HFM14**  
w500 x d140 x h85mm  
bowl w200 x d122 x h50mm

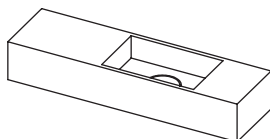

**HFM20**  
w500 x d140 x h85mm  
bowl w200 x d122 x h50mm

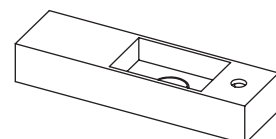

**HFM15**  
w600 x d140 x h85mm  
bowl w200 x d122 x h50mm

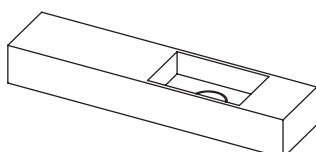

**HFM21**  
w600 x d140 x h85mm  
bowl w200 x d122 x h50mm

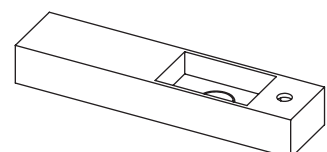

## Materials and colors

Himacs

○ White

## Handrinse layout

Make a choice between Form or Form Light handrinse and fill in positions 1 and 2.  
After this define the size of the bowl. Go to page 113 for the bowl sizes.

### FORM

- ① max. 2000mm
- ② min. 30mm  
min. 80mm with tap hole

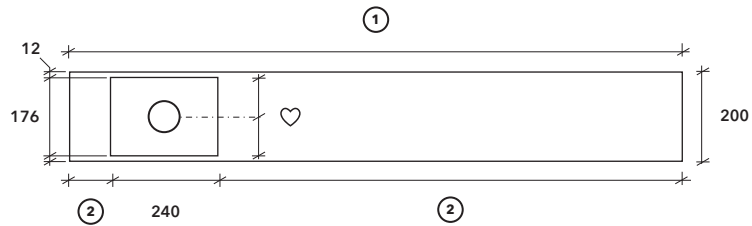

### FORM LIGHT

- ① max. 2000mm
- ② min. 30mm  
min. 80mm with tap hole

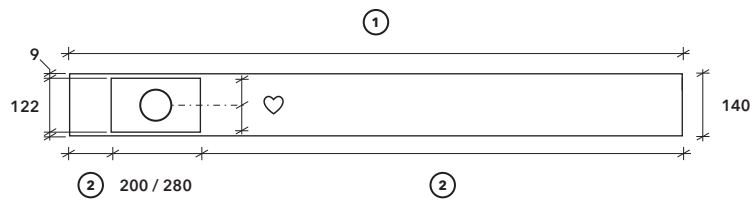

## Edge

Form and Form Light handrinse always comes with a front and back edge. In order to conceal the bowl, Not Only White recommends an edge height as mentioned on the next page at the 'Bowls' section.

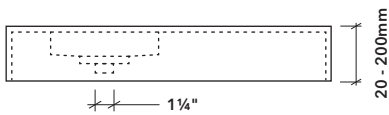

### EH100

Edge 20 - 100mm high

### EH150

Edge 101 - 150mm high

### EH200

Edge 151 - 200mm high

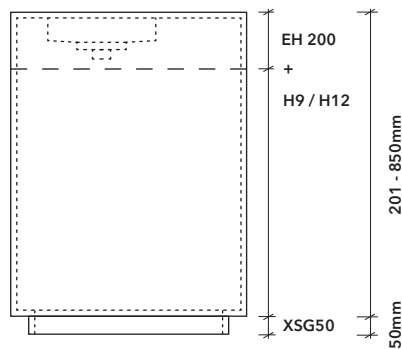

### EH200 + remaining m<sup>2</sup> in H9 for Form Light

Edge 201 - 850mm high

### EH200 + remaining m<sup>2</sup> in H12 for Form

Edge 201 - 850mm high

### XSG50

50mm plinth for floor-standing model

## Bowls

### Form handrinse

#### CHFM24174

w240x d176 x h40mm  
rec. edge height 85mm



#### CHFM24176

w240x d176 x h60mm  
rec. edge height 105mm



#### CHFM24170

w240x d176 x h100mm  
rec. edge height 145mm



### Form Light handrinse

#### CHFML20125

w200 x d122 x h50mm  
rec. edge height 95mm



#### CHFML20128

w200 x d122 x h85mm  
rec. edge height 130mm



#### CHFML28128

w280 x d122 x h85mm  
rec. edge height 130mm



## Drain type

Depending on how the handrinse basin needs to look and work, you can choose from different drain types for Form handrinse.

### 1 FLUSH DRAIN free flow drain

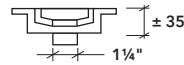

Form handrinse bowls are standard equipped with our Flush drain. This drain allows water to flow through at all times and cannot be closed.

Flush drain is free of charge

### 2 DR72 DRAIN HOLE for a third party drain

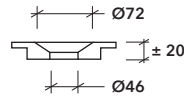

The DR72 drain hole is used for third party drains.

Not Only White recommends to use a free flow drain.

DR72 drain is free of charge

## Overflow

An overflow is not possible.

## Tap hole

If you need to fit a top-mounted tap, we can pre-drill the hole (code **HH35**).

Consider the space you would need to secure the tap with a tightening ring.

### Top-mounted tap without overflow:

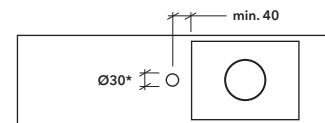

\* Tap hole for UK 35mm

## Mounting holes

To install a handrinse basin to the wall, Not Only White can provide mounting holes (code **OVHL**) in the back edge.

Handrinse basins up to 600mm need two holes. Any handrinse basin wider than 600mm, we advise to have an extra hole up to 1.2m and two extra holes up to 2m.

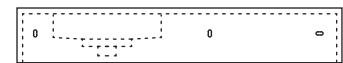

Please refer to **Ribs** for handrinse basins that need to be mounted on a cabinet. In this case mounting holes won't be needed.

## Ribs

Please refer to page 11.

## Cut-outs and edge finishes

Please refer to page 10.

## Materials and colors

Himacs

○ White



# Kuub handrinse

---

Because of its practical dimensions, the Kuub handrinse is a good solution for toilets and cloakrooms. The slot drain gives the Kuub an interesting twist.

Design by Marike Andeweg



## Specifications

- delivered with slot drain
- delivered as wall-mounted version including mounting holes in the back edge
- standard size tap hole Ø30mm; for UK Ø35mm
- Kuub handrinse Models are also available in top-mounted versions

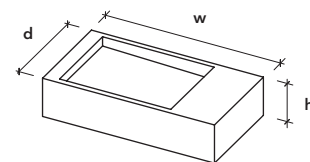

d200mm - no tap hole

**HKB01**  
w370 x d200 x h85mm  
bowl w240 x d176 x h20mm

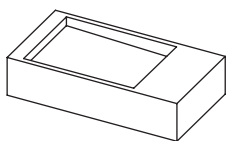

d200mm - with tap hole

**HKB05**  
w370 x d200 x h85mm  
bowl w240 x d176 x h20mm

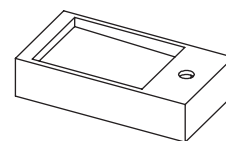

**HKB02**  
w370 x d200 x h130mm  
bowl w240 x d176 x h50mm

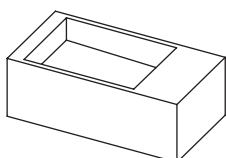

**HKB06**  
w370 x d200 x h130mm  
bowl w240 x d176 x h50mm

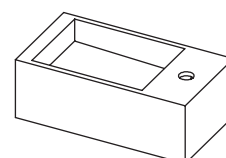

**HKB03**  
w370 x d200 x h85mm  
bowl w240 x d176 x h20mm

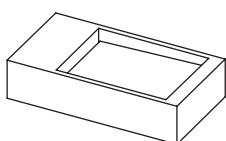

**HKB07**  
w370 x d200 x h85mm  
bowl w240 x d176 x h20mm

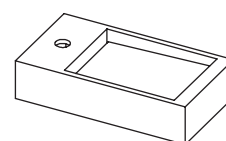

**HKB04**  
w370 x d200 x h130mm  
bowl w240 x d176 x h50mm

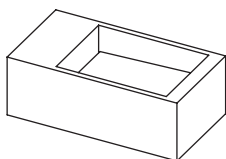

**HKB08**  
w370 x d200 x h130mm  
bowl w240 x d176 x h50mm

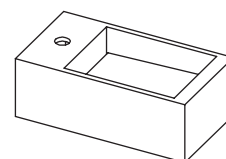

## Materials and colors

Himacs

○ White

# Kuub Light handrinse



---

With its depth of only 14 centimeters, the compact dimensions of the Kuub Light handrinse make it the perfect choice for small spaces. The slot drain gives the Kuub Light handrinse an interesting twist.

Design by Marike Andeweg

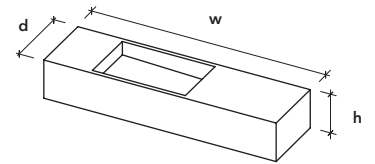

## Specifications

- delivered with slot drain
- delivered as wall-mounted version including mounting holes in the back edge
- standard size tap hole Ø30mm; for UK Ø35mm
- Kuub Light handrinse Models are also available in top-mounted versions

### d140mm - no tap hole

**HKB09**  
w500 x d140 x h85mm  
bowl w200 x d122 x h30mm

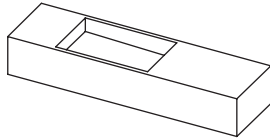

**HKB13**  
w500 x d140 x h85mm  
bowl w200 x d122 x h30mm

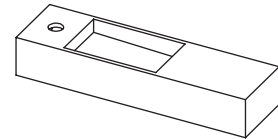

### d140mm - with tap hole

**HKB10**  
w600 x d140 x h85mm  
bowl w200 x d122 x h30mm

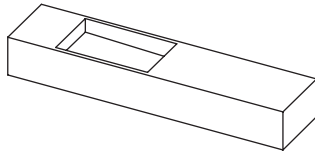

**HKB14**  
w600 x d140 x h85mm  
bowl w200 x d122 x h30mm

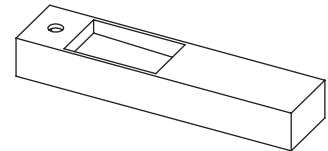

**HKB11**  
w500 x d140 x h85mm  
bowl w200 x d122 x h30mm

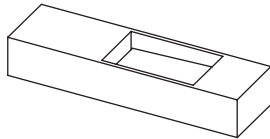

**HKB15**  
w500 x d140 x h85mm  
bowl w200 x d122 x h30mm

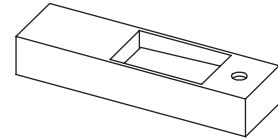

**HKB12**  
w600 x d140 x h85mm  
bowl w200 x d122 x h30mm

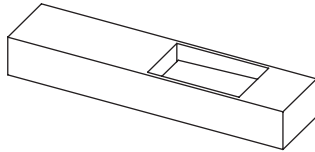

**HKB16**  
w600 x d140 x h85mm  
bowl w200 x d122 x h30mm

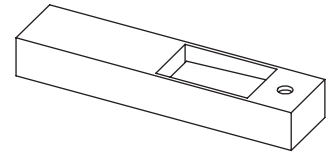

## Materials and colors

Himacs

○ White

## Handrinse layout

Make a choice between Kuub or Kuub Light handrinse and fill in positions 1 and 2.  
After this define the size of the bowl. Go to page 119 for the bowl sizes.

### KUUB

- ① max. 2000mm
- ② min. 30mm  
min. 80mm with tap hole

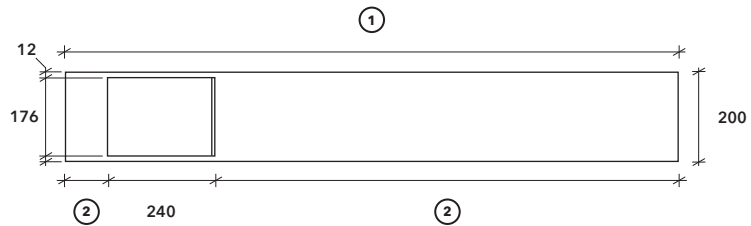

### KUUB LIGHT

- ① max. 2000mm
- ② min. 30mm  
min. 80mm with tap hole

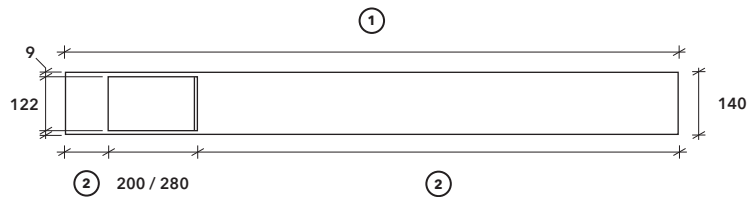

## Edge

Kuub and Kuub Light handrinse always comes with a front and back edge. In order to conceal the bowl, Not Only White recommends an edge height as mentioned on the next page at the 'Bowls' section.

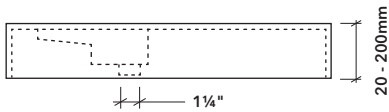

### EH100

Edge 20 - 100mm high

### EH150

Edge 101 - 150mm high

### EH200

Edge 151 - 200mm high

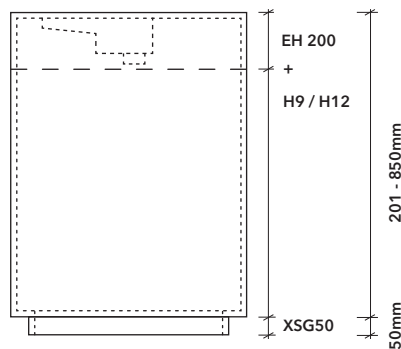

### EH200 + remaining m<sup>2</sup> in H9 for Kuub Light

Edge 201 - 850mm high

### EH200 + remaining m<sup>2</sup> in H12 for Kuub

Edge 201 - 850mm high

### XSG50

50mm plinth for floor-standing model

## Bowls

### Kuub handrinse - drain to right

#### CHKB24172R

w240x d176 x h20mm  
rec. edge height 85mm



#### CHKB24175R

w240x d176 x h50mm  
rec. edge height 115mm



#### CHKB24178R

w240x d176 x h85mm  
rec. edge height 150mm



### Kuub handrinse - drain to left

#### CHKB24172L

w240x d176 x h20mm  
rec. edge height 85mm



#### CHKB24175L

w240x d176 x h50mm  
rec. edge height 115mm



#### CHKB24178L

w240x d176 x h85mm  
rec. edge height 150mm



### Kuub Light handrinse - drain to right

#### CHKBL20123R

w200x d122 x h30mm  
rec. edge height 80mm



#### CHKBL20128R

w200x d122 x h85mm  
rec. edge height 135mm



#### CHKBL28128R

w280x d122 x h85mm  
rec. edge height 135mm



### Kuub Light handrinse - drain to left

#### CHKBL20123L

w200x d122 x h30mm  
rec. edge height 80mm



#### CHKBL20128L

w200x d122 x h85mm  
rec. edge height 135mm



#### CHKBL28128L

w280x d122 x h85mm  
rec. edge height 135mm



## Drain type

Kuub basin is always supplied with a slot drain, as this gives Kuub its distinctive character.

Our slot drain cannot be closed.

## Overflow

An overflow is not possible.

## Tap hole

If you need to fit a top-mounted tap, we can pre-drill the hole (code **HH35**).

Consider the space you would need to secure the tap with a tightening ring.

### Top-mounted tap without overflow:

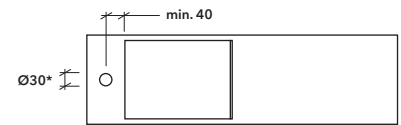

\* Tap hole for UK 35mm

## Mounting holes

To install a handrinse basin to the wall, Not Only White can provide mounting holes (code **OVHL**) in the back edge.

Handrinse basins up to 600mm need two holes. Any handrinse basin wider than 600mm, we advise to have an extra hole up to 1.2m and two extra holes up to 2m.



Please refer to **Ribs** for handrinse basins that need to be mounted on a cabinet. In this case mounting holes won't be needed.

## Ribs

Please refer to page 11.

## Cut-outs and edge finishes

Please refer to page 10.

## Materials and colors

Himacs

○ White



# Noon handrinse



---

The smallest bowl in our Noon collection is the Noon handrinse. This handrinse basin can be used as a countertop model or wall-mounted by using our white powder coated bracket.

Noon handrinse is designed with its own matching white Himacs drain cover to gently merge with the soft rounded shape of the bowl.

Design by Marike Andeweg

## Specifications

- HNN01 is top-mounted
- HNN02-04 comes with a white powder coated bracket
- HNN03-04 tap hole Ø30mm
- HNN10-14 tap hole Ø30mm; for UK Ø35mm

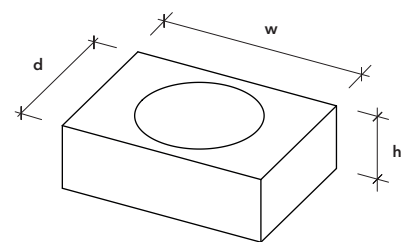
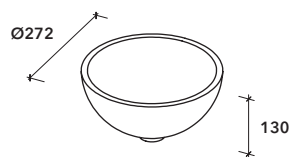

**HNN01**  
Ø272 x h130mm

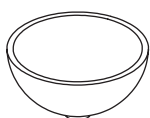

**HNN10**  
w430 x d310 x h135mm  
bowl Ø248 x h116mm

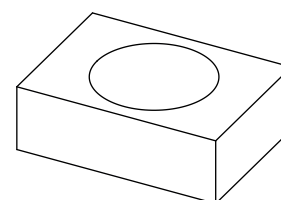

**HNN02**  
Ø272 x h130mm

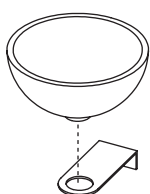

**HNN11**  
w430 x d310 x h135mm  
bowl Ø248 x h116mm

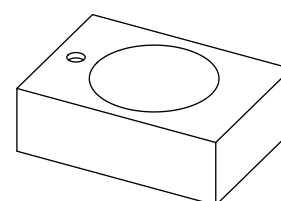

**HNN03**  
Ø272 x h130mm

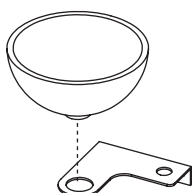

**HNN12**  
w430 x d310 x h135mm  
bowl Ø248 x h116mm

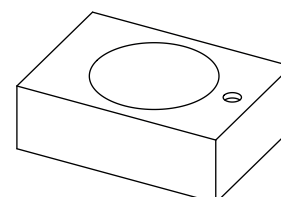

**HNN04**  
Ø272 x h130mm

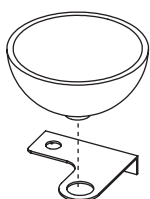

**HNN13**  
w600 x d310 x h135mm  
bowl Ø248 x h116mm

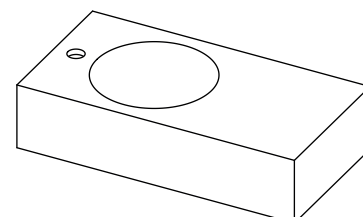

**HNN14**  
w600 x d310 x h135mm  
bowl Ø248 x h116mm

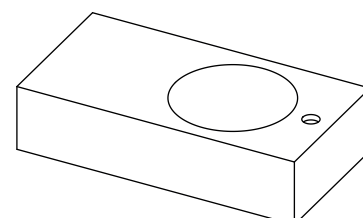

## Materials and colors

Himacs

○ White

Steel

○ White powder coated

## Handrinse layout

Fill in positions 1-5.

- ① max. 5000mm
- ② max. 400mm
- ③ min. 35mm  
min. 90mm with tap hole
- ④ min. 30mm
- ⑤ min. 30mm  
min. 80mm with tap hole

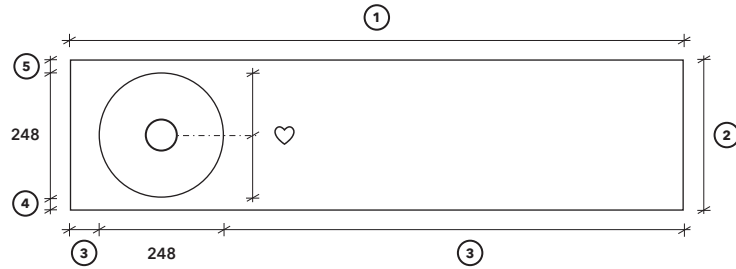

## Edge

Noon handrinse can come with a front and back edge. In order to conceal the bowl, Not Only White recommends an edge height of 135mm.

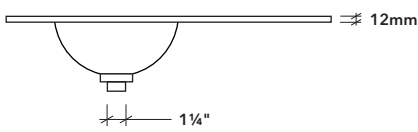

**H12**  
12mm top sheet

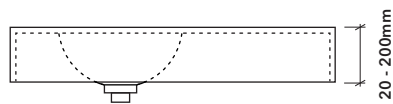

**EH100**  
Edge 20 - 100mm high

**EH150**  
Edge 101 - 150mm high

**EH200**  
Edge 151 - 200mm high

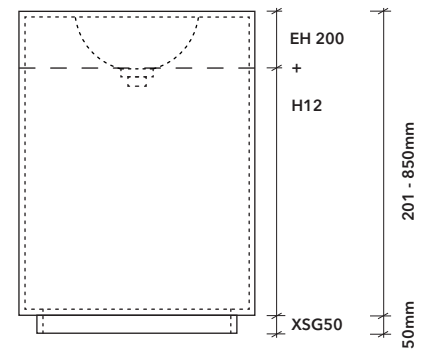

**EH200 + remaining m<sup>2</sup> in H12**  
Edge 201 - 850mm high

**XSG50**  
50mm plinth for floor-standing model

## Bowls

**CHNN01**  
 Ø248 x h116mm  
 rec. edge height 135mm



## Drain type

Depending on how the handrinse basin needs to look and work, you can choose from different drain types for Noon handrinse.



Noon handrinse bowls are standard equipped with a free flow drain. This drain allows water to flow through at all times and cannot be closed.

**Free flow drain is free of charge**



The DR72 drain hole is used for third party drains.

Not Only White recommends to use a free flow drain.

**DR72 drain is free of charge**

## Overflow

An overflow is not possible.

## Tap hole

If you need to fit a top-mounted tap, we can pre-drill the hole (code **HH35**).

Consider the space you would need to secure the tap with a tightening ring.

**Top-mounted tap without overflow:**

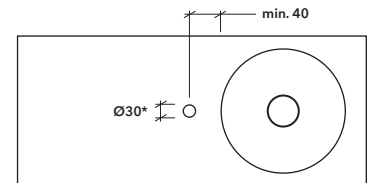

\* Tap hole for UK Ø35mm

## Brackets and ribs

Please refer to page 11, where brackets and ribs are explained, to find out what type of support is needed for your washbasin.

## Cut-outs and edge finishes

Please refer to page 10.

## Materials and colors

**Himacs**      ○ White





Base basin



**Nest** countertop basin

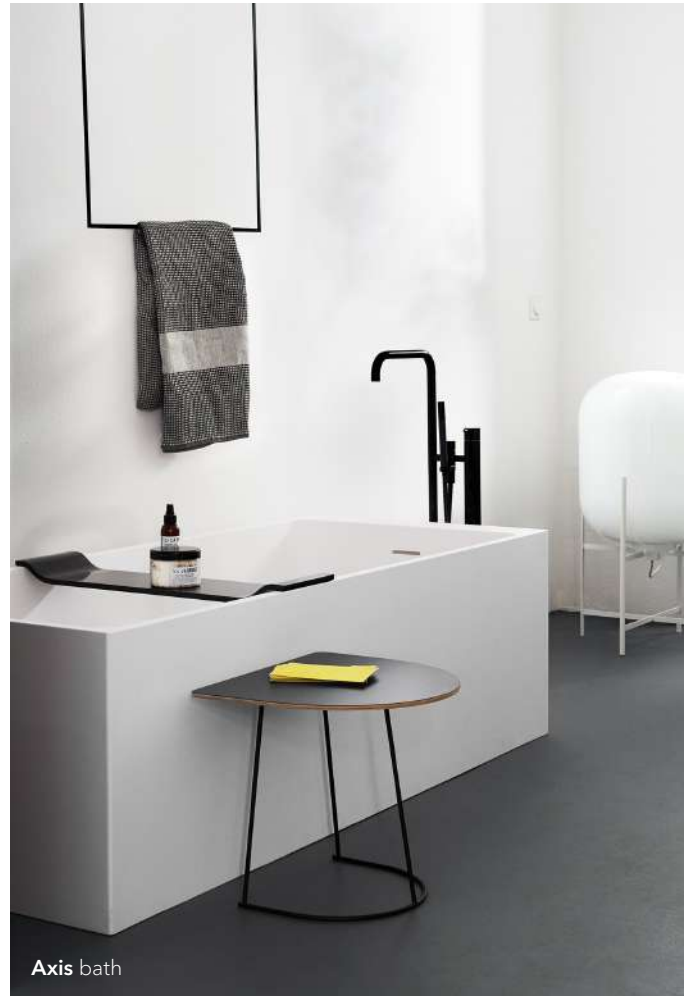

**Axis** bath



**Blend** basin



**Noon** basin



**Mono** basin

## COLOFON

### PUBLISHER

Not Only White B.V.

### PRODUCT DESIGN

**Marike Andeweg** Base, Basq, Blend,  
Box, Flat, Form, Frame, Fuse, Kuub, Leaf,  
Mono, Noon and Unit

**Joost van der Vecht** Aim, Fall and Scape

**Curated by Marike Andeweg** Axis, Ease,  
Fine, Loop, Muse, Nest, Pose and Still

### COVER ILLUSTRATION

Maartje van den Noort

### PRINTING

Van Berkum Graphic Solutions

Not Only White B.V. © 2024

17th edition, April 2024

The colors in this catalogue are by way of illustration only, and may differ from the actual colors.

Not Only White B.V. reserves the rights to alter materials, characteristics and dimensions without prior notice.

All dimensions are in millimeters (mm) unless mentioned otherwise.

Modifications and printing errors reserved.

All models © by Not Only White B.V.

Not Only White is a registered brand name.

Nothing in this catalogue may be copied without the written consent of Not Only White B.V.



Not Only White B.V.  
IJslandstraat 8 bus B2  
8400 Oostend  
Belgium

tel +32 (0)50 800 290

info@notonlywhite.com  
notonlywhite.com